



MARTINI ALFREDO

# CATALOGO PRODOTTI PRODUCT CATALOGUE



PACKAGING SOLUTIONS FOR YOUR BUSINESS



[www.martinalfredo.it](http://www.martinalfredo.it)



## MARTINI ALFREDO S.P.A. DAL 1945, SPAZIO PER LE VOSTRE IDEE.

## MARTINI ALFREDO S.P.A. SPACE FOR YOUR IDEAS SINCE 1945.

### **Una storia di passione e innovazione.**

L'azienda nasce nel 1945 dallo spirito imprenditoriale dell'ingegner Alfredo Martini e porta ancora il suo nome attraverso l'impegno costante della figlia Cristina Martini, Presidente della Società.

### **La solidità dell'esperienza.**

70 anni di specializzazione nello stampaggio a iniezione di contenitori e pallet per la logistica.

### **Il dinamismo della ricerca.**

Tecnologie evolute, collaudi rigorosi, materiali innovativi: affidabilità e sicurezza in ogni condizione d'uso.

### **La flessibilità dei prodotti.**

Ergonomici, modulari, pratici. Per ogni tipo di attività: commercio, servizi, industria o artigianato.

### **La sostenibilità della "Plastica Seconda Vita".**

Il marchio PSV certifica la conformità ecologica per la plastica riciclata da raccolta differenziata (RD) o scarto industriale (SI).



### **A story of passion and innovation.**

The company was founded in 1945 by the entrepreneurial spirit of the engineer Alfredo Martini and still bears his name through the constant commitment of his daughter Cristina Martini, President of the Company.

### **The solidity of the experience.**

70 years of specialization in injection molding of containers and pallet logistics.

### **The dynamic research.**

Advanced technology, rigorous testing, innovative materials: safety and reliability in all conditions.

### **The flexibility of the products.**

Ergonomic, modular, practical. For each type of activity: trade, services, industry or crafts.

### **The sustainability of the "Plastic Second Life".**

The PSV mark certifies ecological compliance for recycled plastic, waste (RD) or industrial (SI).

	<b>Grandi contenitori / Large containers</b>	<b>5</b>
	Cargopallet 700 Plus	6
	Cargopallet 600 Plus New	8
	Cargopallet 300 Plus	9
Logistica e movimentazione Logistics and handling	Cargopallet 700 / 600 New / 300 Plus per prodotti pericolosi solidi	10
	Cargopallet 1300 / 1100 Plus New	12
	Cargopallet 280	13
	Coperchi e accessori Cargopallet	14
	Cargo Fold 700	16
	<b>Pallet / Pallets</b>	<b>18</b>
	Pallet My-L / My-L Bis	20
	Pallet My-N / My-N Bis	22
Logistica e movimentazione Logistics and handling	Pallet My-A / My-A Bis	24
	Travette My-L / My-N / My-A	20/26
	Pallet My-E	28
	Pallet My-P	30
	Pianale / Coperchio per Pallet	31
	Piattaforma grigliata	31
	<b>Contenitori multiuso / Multiple use containers</b>	<b>33</b>
	Alfa	34
	Delta	38
	Delta Mec	40/47
	Delta Mec Fold	48
	Delta Mec 60L / 70 Open	49
Organizzazione e stoccaggio Organization and storage	Delta Mec Misure Speciali	50
	Pettini e Divisori	51
	Coperchi e accessori Delta Mec	52
	Omikron	54
	Tauxi	57
	Tau	58
	Cassonetti Carrellati	60
	Jota	61
	Lambda	62
	Contenitori isotermitici	63
	Gamma	64
	Cestelli	66
	<b>Contenitori detectabili / Detectable containers</b>	<b>68</b>
	<b>Cassettiere e scaffalature / Drawers and shelves</b>	<b>69</b>
	Alfa Mec	70
Industria alimentare Food industry	Rho Kappa	71
	Beta	72
Organizzazione e archiviazione Organization and filing	Memoria	72
	Dedalo e Eta	73
	Mercurio	73
	Pericle	73
	<b>Pavimentazioni componibili / Floor mat elements</b>	<b>75</b>
	Epsilon	76
Pavimentazioni interne e esterne Indoor and outdoor paving systems	Epsilon Plus	76
	Sigma	76
	Legenda	77
	Indici di resistenza del PE e PP	78
	PE and PP resistance indexes	79



# GRANDI CONTENITORI

*Qualità e resistenza alla grande*

# LARGE CONTAINERS

*Quality and resistance on the large scale*

I Cargopallet, progettati per carichi rilevanti, sono resistenti e indeformabili, hanno colonne di rinforzo e fondo nervato. Inerti a contatto di acidi, idrocarburi e solventi.

The Cargopallet, designed for large loads, are resistant and non-deformable, have reinforcement pilasters and ribbed base. They are inert to acids, hydrocarbons and solvents.



- 06 **Cargopallet 700**
- 08 **Cargopallet 600 / 300**
- 10 **Cargopallet Prodotti Pericolosi Solidi  
300 / 600 / 700**
- 12 **Cargopallet 1100 / 1300**
- 13 **Cargopallet 280**
- 14 **Accessori**
- 16 **Cargo Fold 700**



## 700 PLUS

Questo Cargopallet soddisfa le richieste del mercato europeo. 24 versioni: con 4 piedi, 2 o 3 travette, con ruote, con portello, ATX, IND, ortofrutticolo.

This version fulfils the European market needs. 24 versions: with 4 feet, 2 or 3 runners, wheels, folding door ATX, IND, fruit and vegetables.

### Cargopallet 700 Plus



#### Codice Prodotto









-  **80 124 801** / 4 piedi
-  **80 124 802** / 2 travette
-  **80 124 803** / 3 travette
-  **80 124 804** / 4 ruote
-  **80 124 821** / 4 piedi
-  **80 124 822** / 2 travette
-  **80 124 823** / 3 travette
-  **80 124 824** / 4 ruote
-  **Prodotto Personalizzabile**



### Cargopallet 700 Plus con Portello



#### Codice Prodotto

-  **80 124 811** / 4 piedi
-  **80 124 812** / 2 travette
-  **80 124 813** / 3 travette
-  **80 124 814** / 4 ruote
-  **80 124 831** / 4 piedi
-  **80 124 832** / 2 travette
-  **80 124 833** / 3 travette
-  **80 124 834** / 4 ruote
-  **Prodotto Personalizzabile**



### Dati Tecnici

\* Dimensioni del portello 782x40xh326

Dim. esterne	Dim. interne	Dim. est. con ruote	Peso	Incasto impilabilità	Luce tra i piedi	Altezza dei piedi	Capacità max	Portata max	Portata max in sovrapp.
1200x1000xh830	1120x920xh655	1200x1000xh870	31,8 Kg (80 124 801)	20	lato corto 800 lato lungo 830	120	680 dm <sup>3</sup>	600 kg	4000 kg



**E-SHOP**

Scannerizza il QR CODE per accedere direttamente alla pagina ufficiale dello store online.  
Scan the QR CODE to directly access the official page of the online store.

**Cargopallet 700 Plus Grigliato**



**Codice Prodotto**

-  **80 124 851 / 4 piedi**
-  **80 124 852 / 2 travette**
-  **80 124 853 / 3 travette**
-  **80 124 854 / 4 ruote**
-  **Prodotto Personalizzabile**



**Cargopallet 700 Plus Grigliato con Portello**

**VENDITA LEGATA A QUANTITATIVI MINIMI**



**Codice Prodotto**

-  **80 124 861 / 4 piedi**
-  **80 124 862 / 2 travette**
-  **80 124 863 / 3 travette**
-  **80 124 864 / 4 ruote**
-  **Prodotto Personalizzabile**



**Dati Tecnici**

\* Dimensioni del portello 782x40xh326

Dim. esterne	Dim. interne	Dim. est. con ruote	Peso	Incasto impilabilità	Luce tra i piedi	Altezza dei piedi	Capacità max	Portata max	Portata max in sovrapp.
1200x 1000x h830	1120x 920x h655	1200x 1000x h870	31,2 Kg (80 124 851)	20	lato corto 800 lato lungo 830	120	680 dm <sup>3</sup>	600 kg	4000 kg

# GRANDI CONTENITORI / LARGE CONTAINERS

LOGISTICA E MOVIMENTAZIONE / LOGISTICS AND HANDLING

## CARGOPALLET PLUS

### 600 NEW / 300 PLUS

I contenitori 600 New sono ancora più robusti grazie all'elevato irrigidimento delle pareti. Disponibili con piedini, travette o ruote.

These 600 New containers are sturdy and reliable. The interior walls are smooth. Available with feet, runners or wheels.

#### Cargopallet 600 Plus New



Codice Prodotto

- |                                                     |                                                     |
|-----------------------------------------------------|-----------------------------------------------------|
| <b>30 185 740 N</b> / 4 piedi                       | <b>30 185 753 N</b> / 4 piedi                       |
| <b>30 185 763 N</b> / 2 travette                    | <b>30 185 764 N</b> / 2 travette                    |
| <b>30 185 807 N</b> / 3 travette                    | <b>30 185 808 N</b> / 3 travette                    |
| <b>30 185 770 N</b> / 4 travette                    | <b>30 185 771 N</b> / 4 travette                    |
| <b>30 185 748 N</b> / 4 ruote angoli                | <b>30 185 776 N</b> / 4 ruote angoli                |
| <b>30 124 803 N</b> / 4 ruote centro                | <b>30 185 804 N</b> / 4 ruote centro                |
| <b>30 185 778 N</b> / 4 ruote angoli<br>plt arancio | <b>30 185 777 N</b> / 4 ruote angoli<br>plt arancio |
| <b>30 185 805 N</b> / 4 ruote centro<br>plt arancio | <b>30 185 806 N</b> / 4 ruote centro<br>plt arancio |
| <b>30 185 745 N</b> / 2 travette<br>e 4 ruote       | <b>30 185 746 N</b> / 2 travette<br>e 4 ruote       |



**Prodotto Personalizzabile**

#### Cargopallet 600 Plus New con Portello



Codice Prodotto

- |                                               |                                               |
|-----------------------------------------------|-----------------------------------------------|
| <b>80 124 502 N</b> / 4 piedi                 | <b>80 124 552 N</b> / 4 piedi                 |
| <b>80 124 503 N</b> / 2 travette              | <b>80 124 553 N</b> / 2 travette              |
| <b>80 124 516 N</b> / 3 travette              | <b>80 124 517 N</b> / 3 travette              |
| <b>80 124 506 N</b> / 4 travette              | <b>80 124 557 N</b> / 4 travette              |
| <b>80 124 504 N</b> / 4 ruote angoli          | <b>80 124 554 N</b> / 4 ruote angoli          |
| <b>80 124 514 N</b> / 4 ruote centro          | <b>80 124 564 N</b> / 4 ruote centro          |
| <b>80 124 505 N</b> / 2 travette<br>e 4 ruote | <b>80 124 555 N</b> / 2 travette<br>e 4 ruote |



**Prodotto Personalizzabile**

#### Dati Tecnici

Cargopallet 600 Plus/Grigliato/con Portello

\* Dimensioni del portello 782x40xh326

Dim. esterne	Dim. interne	Dim. est. con ruote al centro	Dim. est. con ruote ali angoli	Peso	Incasto impilabilità	Luce tra i piedi	Altezza dei piedi	Capacità max	Portata max	Portata max in sovrapp.
1200x800xh850	1130x725xh690	1200x800xh900	1200x800xh1000	25,2 Kg (30 185 740 N)	35	lato corto 600 lato lungo 830	120	550 dm <sup>3</sup>	500 kg	2000 kg



CARGOPALLET 600  
PLUS NEW



CARGOPALLET 300  
PLUS

### E-SHOP

Scannerizza il QR CODE per accedere direttamente alla pagina ufficiale dello store online.

Scan the QR CODE to directly access the official page of the online store.

#### Cargopallet 600 Plus Grigliato



Codice Prodotto

- 80 124 340** / 4 piedi
- 80 124 341** / 2 travette
- 80 124 351** / 4 travette
- 80 124 342** / 4 ruote
- 80 124 347** / 4 ruote  
plt arancio
- 80 124 348** / 2 travette  
e 4 ruote
- 80 124 360** / 4 piedi
- 80 124 361** / 2 travette
- 80 124 371** / 4 travette
- 80 124 362** / 4 ruote
- 80 124 367** / 4 ruote  
plt arancio
- 80 124 368** / 2 travette  
e 4 ruote

**Prodotto Personalizzabile**



#### Cargopallet 300 Plus



Codice Prodotto

- 80 124 150** / 4 piedi
- 80 124 151** / 2 travette
- 80 124 152** / 4 ruote
- 80 124 157** / 2 travette  
e 4 ruote
- 80 124 180** / 4 piedi
- 80 124 181** / 2 travette
- 80 124 182** / 4 ruote
- 80 124 185** / 2 travette  
e 4 ruote

**Prodotto Personalizzabile**



#### Dati Tecnici

#### Cargopallet 300 Plus

Dim. esterne	Dim. interne	Dim. est. con ruote ali angoli	Peso	Incasto impilabilità	Luce tra i piedi	Altezza dei piedi	Capacità max	Portata max	Portata max in sovrapp.
1000x 700x h650	940x 640x h500	1000x 700x h800	14,4 Kg (80 124 150)	35	lato corto 505 lato lungo 640	120	297 dm <sup>3</sup>	300 kg	1200 kg

## CARGOPALLET 700 PRODOTTI PERICOLOSI SOLIDI

I Cargopallet 300/600 New/700 Plus, sono realizzati nel pieno rispetto della normativa ADR e sono adatti per il trasporto e stoccaggio terrestre e ferroviario dei prodotti pericolosi solidi (UN 2794, UN 2795, UN 2800, UN 3028). Il Cargopallet 600 New per Prodotti Pericolosi Solidi è omologato anche al trasporto e stoccaggio di batterie al litio (UN 3091).

The Cargopallet 300/600 New/700 Plus, are manufactured in full compliance with the ADR regulations and are suitable for transporting and storing terrestrial and railway solid hazardous products (UN 2794, UN 2795, UN 2800, UN 3028). The 600 New Cargopallet for Solid Hazardous Products is also used for the transportation and storage of lithium batteries (UN 3091).

### Cargopallet 700 Prodotti Pericolosi Solidi



Codice Prodotto



80 124 870 / 3 travette



Batterie Esauste / Low Battery



### Cargopallet 600 New Prodotti Pericolosi Solidi



Codice Prodotto



30 185 743 N / 2 travette



Batterie Esauste / Low Battery



Li-ion Batterie al Litio / Lithium Battery



### Cargopallet 300 Prodotti Pericolosi Solidi



Codice Prodotto



80 124 162 / 2 travette



Batterie Esauste / Low Battery

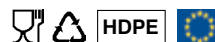



#### E-SHOP

Scannerizza il QR CODE per accedere direttamente alla pagina ufficiale dello store online.

Scan the QR CODE to directly access the official page of the online store.

#### Cargopallet 700 Prodotti Pericolosi Solidi

##### Dati Tecnici

Dim. esterne	Dim. interne	Peso	Incasso impilabilità	Luce tra i piedi	Altezza dei piedi	Capacità max	Portata max	Portata max in sovrapp.
1200x1000xh830	1120x920xh655	38,3 Kg	20	lato corto 800 lato lungo 830	120	680 dm <sup>3</sup>	500 kg	1500 kg

#### Cargopallet 600 New Prodotti Pericolosi Solidi

##### Dati Tecnici

Dim. esterne	Dim. interne	Peso	Incasso impilabilità	Luce tra i piedi	Altezza dei piedi	Capacità max	Portata max	Portata max in sovrapp.
1200x800xh850	1130x725xh690	30,6 Kg	35	lato corto 600 lato lungo 830	120	550 dm <sup>3</sup>	500 kg	1500 kg

#### Cargopallet 300 Prodotti Pericolosi Solidi

##### Dati Tecnici

Dim. esterne	Dim. interne	Peso	Incasso impilabilità	Luce tra i piedi	Altezza dei piedi	Capacità max	Portata max	Portata max in sovrapp.
1000x700xh650	940x640xh500	19,2 Kg	35	lato corto 505 lato lungo 640	120	297 dm <sup>3</sup>	300 kg	900 kg

# GRANDI CONTENITORI / LARGE CONTAINERS

LOGISTICA E MOVIMENTAZIONE / LOGISTICS AND HANDLING

## CARGOPALLET PLUS

### 1300 / 1100 PLUS NEW

Dotabile di porta-etichetta, piedi, travette e ruote. Disponibile anche nella versione per alimenti, non è adatto ai liquidi.

Not suitable for liquids. Also available for foodstuffs. Fitted with feet, runners or wheels.

#### Cargopallet 1300 Plus



Codice Prodotto

-  **80 124 901** / 4 piedi
  -  **80 124 902** / 2 travette
  -  **80 124 903** / 3 travette
  -  **80 124 919** / 4 piedi e portello
  -  **80 124 911** / 4 piedi
  -  **80 124 912** / 2 travette
  -  **80 124 913** / 3 travette
  -  **80 124 916** / 4 piedi e portello
-  **Prodotto Personalizzabile**



#### E-SHOP









Scannerizza il QR CODE per accedere direttamente alla pagina ufficiale dello store online.

Scan the QR CODE to directly access the official page of the online store.

#### Cargopallet 1100 Plus New



Codice Prodotto

-  **30 185 835 N** / 4 piedi
  -  **30 185 836 N** / 2 travette
  -  **30 185 837 N** / 4 travette
  -  **30 185 838 N** / 4 piedi e portello
  -  **30 185 820 N** / 4 piedi
  -  **30 185 830 N** / 2 travette
  -  **30 185 831 N** / 4 travette
  -  **30 185 827 N** / 4 piedi e portello
-  **Prodotto Personalizzabile**



#### Dati Tecnici

Cargopallet 1300/1100 Plus New

\* Dimensioni del portello 782x40xh326

Prodotto	Dim. esterne	Dim. interne	Peso	Incasso impilabilità	Luce tra i piedi	Altezza dei piedi	Capacità max
<b>Cargopallet 1300</b>	1200x1000xh1450	1120x920xh1270	51,0 Kg (80 124 901)	20	lato corto 800 lato lungo 830	120	1300 dm <sup>3</sup>
<b>Cargopallet 1100 Plus New</b>	1200x800xh1510	1130x725xh1350	42,5 Kg (30 185 835 N)	35	lato corto 600 lato lungo 830	120	1100 dm <sup>3</sup>

## 280





Il Cargopallet 280 è studiato e realizzato per lo stoccaggio ed il trasporto di generi alimentari. Portata fino a 150 Kg di prodotto senza deformazione del fondo.

The Cargopallet 280 has been designed to store and to transport food and vegetables. It can be loaded up to 150 Kg with no bottom deformation.

### Cargopallet 280



Codice Prodotto

-  **80 124 600**
-  **80 124 601 / 4 piedi**
-  **80 124 602 / 4 ruote**
-  **Prodotto Personalizzabile**



### E-SHOP

Scannerizza il QR CODE per accedere direttamente alla pagina ufficiale dello store online.  
Scan the QR CODE to directly access the official page of the online store.

### Dati Tecnici

Dim. esterne	Dim. interne	Dim. esterne con piedi	Dim. esterne con ruote	Peso	Luce tra i piedi	Altezza dei piedi	Portata max	Portata max in sovrapp.
1200x 1000x h234	1129x 929x h195	1200x 1000x h350	1200x 1000x h500	12,2 Kg (80 124 600)	lato corto 590 lato lungo 790	100	150 kg	1500 Kg

## COPERCHI

Scegliete il coperchio più congeniale per completare il vostro Cargopallet.

To complete your Cargopallet you can select the most suitable lid.

### I Coperchi



**Coperchio 300**



**Coperchi 600/1100**



**Coperchio 600 con portello**



**Coperchi 700/1300**



**Coperchio 700 con portello**

Codice Prodotto

#### Coperchio 300



**30 194 650**



**30 194 680**



**30 194 652 / maniglia**



**30 194 682 / maniglia**

#### Coperchi 600/1100



**30 194 639**



**30 194 637**



**30 194 634 / maniglia**



**30 194 633 / maniglia**

#### Coperchio 600 con portello



**30 194 642**



**30 194 643**



**30 194 644 / maniglia**



**30 194 645 / maniglia**

#### Coperchi 700/1300



**30 194 700**



**30 194 705**



**30 194 701 / maniglia**



**30 194 706 / maniglia**

#### Coperchio 700 con portello



**30 194 710**



**30 194 715**



**30 194 711 / maniglia**



**30 194 716 / maniglia**



### E-SHOP

Scannerizza il QR CODE per accedere direttamente alla pagina ufficiale dello store online.

Scan the QR CODE to directly access the official page of the online store.

### Dati Tecnici

Coperchio 300	Coperchi 600/1100	Coperchio 600 con portello	Coperchi 700/1300	Coperchi 700 con portello
Dimensioni Esterne 1020x720xh30/65	Dimensioni Esterne 1215x815xh30/65	Dimensioni Esterne 1215x815xh30/65	Dimensioni Esterne 1216x1014xh30/65	Dimensioni Esterne 1216x1014xh30/65

## ACCESSORI

Scegliete l'accessorio più congeniale per completare il vostro Cargopallet.

To complete your Cargopallet you can select the most suitable accessory.

### Accessori



**Rubinetto a sfera**



**Tappo a vite**



**Portaetichette**  
per 300-600-700-1100-1300



**Portadocumenti A4/A5  
per cargo**



**Travette**



**Ruota standard**



**Ruota speciale**



**Traversina con ruote**

Codice Prodotto

#### Rubinetto a sfera

**80 466 001** / Utile in caso stoccaggio liquidi

#### Tappo a vite

**80 466 002** / Realizzato in resina

#### Portaetichette per 300-600-700-1100-1300

**30 005 633** / 165x120xh1,5

#### Portadocumenti A4/A5 per cargo

**30 005 650A** / 295x215xh10

#### Travette

Per l'utilizzo di carrelli elevatori con forche rotanti

#### Ruota standard

Per carichi inferiori ai 400 Kg. (*Freno su richiesta*)

#### Ruota speciale

Per carichi superiori ai 400 Kg. (*Freno su richiesta*)

#### Travette con ruote

Per agevolare lo spostamento dei cargopallet senza l'ausilio di carrelli elevatori. (*Freno su richiesta*)



### E-SHOP

Scannerizza il QR CODE per accedere direttamente alla pagina ufficiale dello store online.  
Scan the QR CODE to directly access the official page of the online store.

# GRANDI CONTENITORI / LARGE CONTAINERS

LOGISTICA E MOVIMENTAZIONE / LOGISTICS AND HANDLING

CARGO FOLD

## CARGO FOLD 700

Cargo Fold 700, ideale per risolvere la logistica del ritorno degli imballi grazie al notevole risparmio di spazio quando è ripiegato. Disponibile anche con ruote.

Cargo Fold 700, the best product when the logistic calls for packaging return thanks to the considerable space saving when folded. It is also available with wheels.

### Cargo Fold 700



Codice Prodotto

- 80 124 701 / 4 piedi
- 80 124 702 / 2 travette
- 80 124 703 / 3 travette
- 80 124 705 / 4 ruote
- 80 124 721 / 4 piedi
- 80 124 722 / 2 travette
- 80 124 723 / 3 travette
- 80 124 725 / 4 ruote
- Prodotto Personalizzabile



### Cargo Fold 700 con Portello



Codice Prodotto

- 80 124 711 / 4 piedi
- 80 124 712 / 2 travette
- 80 124 713 / 3 travette
- 80 124 715 / 4 ruote
- 80 124 731 / 4 piedi
- 80 124 732 / 2 travette
- 80 124 733 / 3 travette
- 80 124 735 / 4 ruote
- Prodotto Personalizzabile

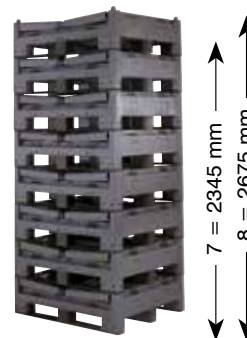

Ripiegato risparmio del 63% del volume  
Folded 63% less volume

### Dati Tecnici

\* Dimensioni del portello 782x40xh326

Dim. esterne	Dim. interne	Dim. est. con ruote	Peso	Cont. chiuso	Incasto impilabilità	Luce tra i piedi	Altezza dei piedi	Capacità max	Portata max	Portata max in sovrapp.
1200x1000xh847	1120x920xh654	1220x1000xh854	36,0 Kg (80 124 701)	h 365	35	lato corto 800 lato lungo 830	120	650 dm <sup>3</sup>	600 kg Cargo 700 Fold / 3 travi	2400 Kg



### E-SHOP

Scannerizza il QR CODE per accedere direttamente alla pagina ufficiale dello store online.  
Scan the QR CODE to directly access the official page of the online store.

### Cargo Fold 700 Grigliato



Codice Prodotto

- 80 124 751 / 4 piedi
- 80 124 752 / 2 travette
- 80 124 753 / 3 travette
- 80 124 755 / 4 ruote
- 80 124 771 / 4 piedi
- 80 124 772 / 2 travette
- 80 124 773 / 3 travette
- 80 124 775 / 4 ruote
- Prodotto Personalizzabile



### Cargo Fold 700 Grigliato con Portello

### VENDITA LEGATA A QUANTITATIVI MINIMI



Codice Prodotto

- 80 124 761 / 4 piedi
- 80 124 762 / 2 travette
- 80 124 763 / 3 travette
- 80 124 765 / 4 ruote
- 80 124 781 / 4 piedi
- 80 124 782 / 2 travette
- 80 124 783 / 3 travette
- 80 124 785 / 4 ruote
- Prodotto Personalizzabile



### Dati Tecnici

\* Dimensioni del portello 782x40xh326

Dim. esterne	Dim. interne	Dim. est. con ruote	Peso	Cont. chiuso	Incasto impilabilità	Luce tra i piedi	Altezza dei piedi	Capacità max	Portata max	Portata max in sovrapp.
1200x1000xh847	1120x920xh654	1220x1000xh854	34,3 Kg (80 124 751)	h 365	35	lato corto 800 lato lungo 830	120	650 dm <sup>3</sup>	600 kg Cargo 700 Fold / 3 travi	2400 Kg



## PALLET

*Funzionalità inarrstabile*

## PALLETS

*Quality and resistance on the large scale*

Imputrescibili, con tara costante e superficie antiscivolo, impilabili o con travette: sono disponibili svariati modelli in funzione del carico che devono trasportare.

Rot-proof, constant tare, non-slip surfaces, nestable or with runners: several versions are available depending on the specific payload.



- 20 **Pallet My-L/My-L Bis**
- 22 **Pallet My-N/My-N Bis**
- 24 **Pallet My-A/My-A Bis**
- 28 **Pallet My-E**
- 30 **Pallet My-P**
- 31 **Pianale/Coperchio per Pallet  
Piattaforma Grigliata**



# PALLET / PALLETS

LOGISTICA E MOVIMENTAZIONE / LOGISTICS AND HANDLING

## PALLET INSERIBILI E CON TRAVETTE

### MY-L/MY-L BIS

**Carico leggero.** I Pallet My-L sono leggeri, resistenti e utilizzabili anche come "pallet a perdere".

**Lightweight payloads.** The My-L Pallets are lightweight, resistant and can also be used as one way pallets.

#### My-L 800x1200



Codice Prodotto

- 30 560 100 / RPE / h135
- Prodotto Personalizzabile



#### My-L Bis 800x1200



Codice Prodotto

- 82 560 600 / RPE / h160
- Travette 90x1200
- 30 912 520 / RPE / h25 Per Pallet My-L 800x1200
- Prodotto Personalizzabile



#### Dati Tecnici

Prodotto	Dimensioni	Peso	Capacità Statica	Capacità Dinamica
Pallet My-L 800x1200	800x1200xh135	4,8 Kg	1500 kg	600 kg
Pallet My-L Bis 800x1200	800x1200xh160	6,9 Kg	1500 kg	600 kg

#### Dati Logistici

Prodotto	20' DV	40' DV	40' HC	45' WB
Pallet My-L 800x1200	528 pz.	1200 pz.	1375 pz.	1815 pz.
Pallet My-L Bis 800x1200	231 pz.	483 pz.	529 pz.	690 pz.

# PALLET / PALLETS

LOGISTICA E MOVIMENTAZIONE / LOGISTICS AND HANDLING

## PALLET INSERIBILI E CON TRAVETTE



### E-SHOP

Scannerizza il QR CODE per accedere direttamente alla pagina ufficiale dello store online.  
Scan the QR CODE to directly access the official page of the online store.

#### My-L 1000x1200



Codice Prodotto

- 30 560 120 / RPE / h140
- Prodotto Personalizzabile



#### My-L Bis 1000x1200



Codice Prodotto

- 80 560 601 / RPE / h165
- Travette 115x1200
- 30 912 522V / RPE / h25 Per Pallet My-L 1000x1200
- Prodotto Personalizzabile



### Dati Tecnici

Prodotto	Dimensioni	Peso	Capacità Statica	Capacità Dinamica
Pallet My-L 1000x1200	1000x1200xh140	6,3 Kg	1500 kg	600 kg
Pallet My-L Bis 1000x1200	1000x1200xh165	9,54 Kg	1500 kg	600 kg

### Dati Logistici

Prodotto	20' DV	40' DV	40' HC	45' WB
Pallet My-L 1000x1200	500 pz.	1100 pz.	1320 pz.	1560 pz.
Pallet My-L Bis 1000x1200	210 pz.	420 pz.	460 pz.	552 pz.

# PALLET / PALLETS

LOGISTICA E MOVIMENTAZIONE / LOGISTICS AND HANDLING

## PALLET INSERIBILI E CON TRAVETTE

### MY-N/MY-N BIS

**Carico leggero.** I Pallet My-N hanno il piano di appoggio a maglia quadra e si prestano per un utilizzo intensivo.

**Lightweight payloads.** The My-N Pallets have square mesh support surface and are suitable for intensive use.

#### My-N 1000x1200



Codice Prodotto

- 30 560 062 / RPP / h140
- Prodotto Personalizzabile



#### My-N Bis 1000x1200



Codice Prodotto

- 82 560 350 / RPP / h165
- Travette 115x1200
- 30 912 522V / RPE / h25 Per Pallet My-N 1000x1200
- Prodotto Personalizzabile



#### Dati Tecnici

Prodotto	Dimensioni	Peso	Capacità Statica	Capacità Dinamica
Pallet My-N 1000x1200	1000x1200xh140	9,2 Kg	4000 kg	600 kg
Pallet My-N Bis 1000x1200	1000x1200xh165	12,44 Kg	4000 kg	600 kg

#### Dati Logistici

Prodotto	20' DV	40' DV	40' HC	45' WB
Pallet My-N 1000x1200	500 pz.	1100 pz.	1320 pz.	1560 pz.
Pallet My-N Bis 1000x1200	210 pz.	420 pz.	460 pz.	552 pz.

# PALLET / PALLETS

LOGISTICA E MOVIMENTAZIONE / LOGISTICS AND HANDLING

## PALLET INSERIBILI E CON TRAVETTE



### E-SHOP

Scannerizza il QR CODE per accedere direttamente alla pagina ufficiale dello store online.

Scan the QR CODE to directly access the official page of the online store.

#### My-N 1200x1200



Codice Prodotto

- 30 560 088 / RPP / h140
- Prodotto Personalizzabile



#### My-N Bis 1200x1200



Codice Prodotto

- 82 560 400 / RPP / h165
- Travette 115x1200
- 30 912 522V / RPE / h25 Per Pallet My-N 1200x1200
- Prodotto Personalizzabile



### Dati Tecnici

Prodotto	Dimensioni	Peso	Capacità Statica	Capacità Dinamica
Pallet My-N 1200x1200	1200x1200xh140	11,1 Kg	4000 kg	600 kg
Pallet My-N Bis 1200x1200	1200x1200xh165	14,34 Kg	4000 kg	600 kg

### Dati Logistici

Prodotto	20' DV	40' DV	40' HC	45' WB
Pallet My-N 1200x1200	200 pz.	500 pz.	600 pz.	1320 pz.
Pallet My-N Bis 1200x1200	84 pz.	84 pz.	92 pz.	460 pz.

# PALLET / PALLETS

LOGISTICA E MOVIMENTAZIONE / LOGISTICS AND HANDLING

## PALLET INSERIBILI E CON TRAVETTE

### MY-A/MY-A BIS

**Carico medio.** Superficie a geometria alveolare. Robusti e solidi grazie alla "maglia alveolare" che li rende ideali per uso anche molto intensivo.

**Medium payloads.** Honeycomb geometry of the surface. This special surface mesh makes them very sturdy, solid and ideal for very intensive use.

#### My-A 400x600



Codice Prodotto

- 30 560 250 / RPE / h125
- 30 560 251 / RPE / h133 / con bordo
- Prodotto Personalizzabile



#### My-A 600x800



Codice Prodotto

- 30 560 200 / RPE / h140
- 30 560 201 / PE / h140
- 30 560 202 / RPE / h148 / con bordo
- 30 560 203 / PE / h148 / con bordo
- Prodotto Personalizzabile



#### Dati Tecnici

Prodotto	Dimensioni	Peso	Capacità Statica	Capacità Dinamica
Pallet My-A 400x600	400x600xh125 400x600xh133 con bordo	1,55 Kg (30 560 250)	1000 kg	400 kg
Pallet My-A 600x800	600x800xh140 600x800xh148 con bordo	3,2 Kg (30 560 200)	3000 kg	600 kg

#### Dati Logistici

Prodotto	20' DV	40' DV	40' HC	45' WB
Pallet My-A 400x600	3300 pz.	7500 pz.	7500 pz.	9900 pz.
Pallet My-A 600x800	1320 pz.	3000 pz.	3000 pz.	3960 pz.

# PALLET / PALLETS

LOGISTICA E MOVIMENTAZIONE / LOGISTICS AND HANDLING

## PALLET INSERIBILI E CON TRAVETTE



### E-SHOP

Scannerizza il QR CODE per accedere direttamente alla pagina ufficiale dello store online.

Scan the QR CODE to directly access the official page of the online store.

#### My-A 800x1200

**\* VENDITA LEGATA A QUANTITATIVI MINIMI**



Codice Prodotto

- 30 560 400 / RPE / h140
- ☒ 30 560 401 / PE / h140
- 30 560 402 / RPE / h148 con bordo
- ☒ 30 560 403 / PE / h148 con bordo
- 30 560 409\* / RPE / h140
- 30 560 411\* / RPE / h140
- 30 560 412\* / RPE / h140
- Prodotto Personalizzabile



#### My-A Bis 800x1200



Codice Prodotto

- 82 560 700 / RPE / h165 ☒ 82 560 701 / PE / h165
- 82 560 702 / RPE / h173 con bordo ☒ 82 560 703 / PE / h173 con bordo
- Prodotto Personalizzabile

#### Travette 115x1200

- 30 912 522V / RPE / h25
- ☒ 30 912 523V / PE / h25

Per Pallet My-A 800x1200



### Dati Tecnici

Prodotto	Dimensioni	Peso	Capacità Statica	Capacità Dinamica
Pallet My-A 800x1200	800x1200xh140 800x1200xh148 con bordo	8,1 Kg (30 560 400)	4000 kg	1200 kg
Pallet My-A Bis 800x1200	800x1200xh165 800x1200xh173 con bordo	11,34 Kg (82 560 700)	4000 kg	1200 kg

### Dati Logistici

Prodotto	20' DV	40' DV	40' HC	45' WB
Pallet My-A 800x1200	550 pz.	1250 pz.	1500 pz.	1980 pz.
Pallet My-A Bis 800x1200	231 pz.	462 pz.	506 pz.	644 pz.

# PALLET / PALLETS

LOGISTICA E MOVIMENTAZIONE / LOGISTICS AND HANDLING

## PALLET INSERIBILI E CON TRAVETTE



### E-SHOP

Scannerizza il QR CODE per accedere direttamente alla pagina ufficiale dello store online.

Scan the QR CODE to directly access the official page of the online store.

#### My-A 1000x1200



Codice Prodotto

- 30 560 450** / RPE / h140
- 30 560 451** / PE / h140
- 30 560 452** / RPE / h148 con bordo
- 30 560 453** / PE / h148 con bordo
- Prodotto Personalizzabile**



#### My-A Bis 1000x1200



Codice Prodotto

- 82 560 750** / RPE / h165
- 82 560 751** / PE / h165
- 82 560 752** / RPE / h173 con bordo
- 82 560 753** / PE / h173 con bordo



#### Travette 115x1200

- 30 912 522V** / RPE / h25
- 30 912 523V** / PE / h25
- Per Pallet My-A 1000x1200
- Prodotto Personalizzabile**



### Dati Tecnici

Prodotto	Dimensioni	Peso	Capacità Statica	Capacità Dinamica
Pallet My-A 1000x1200	1000x1200xh140 1000x1200xh148 con bordo	9,25 Kg (30 560 450)	4000 kg	1200 kg
Pallet My-A Bis 1000x1200	1000x1200xh165 1000x1200xh173 con bordo	12,49 Kg (82 560 750)	4000 kg	1200 kg

### Dati Logistici

Prodotto	20' DV	40' DV	40' HC	45' WB
Pallet My-A 1000x1200	500 pz.	1100 pz.	1320 pz.	1560 pz.
Pallet My-A Bis 1000x1200	210 pz.	420 pz.	460 pz.	552 pz.

# PALLET / PALLETS

LOGISTICA E MOVIMENTAZIONE / LOGISTICS AND HANDLING

## PALLET INSERIBILI E CON TRAVETTE



### E-SHOP

Scannerizza il QR CODE per accedere direttamente alla pagina ufficiale dello store online.

Scan the QR CODE to directly access the official page of the online store.

#### My-A 1135x1135



Codice Prodotto

- 30 560 300 / RPE / h140
- ☞ 30 560 301 / PE / h140
- 30 560 302 / RPE / h148 con bordo
- ☞ 30 560 303 / PE / h148 con bordo
- Prodotto Personalizzabile



#### My-A Bis 1135x1135



Codice Prodotto

- 82 560 800 / RPE / h165
- ☞ 82 560 801 / PE / h165
- 82 560 802 / RPE / h173 con bordo
- ☞ 82 560 803 / PE / h173 con bordo
- Prodotto Personalizzabile



#### Travette 115x1135

- 30 912 524V / RPE / h25
- ☞ 30 912 525V / PE / h25
- Per Pallet My-A 1135x1135



### Dati Tecnici

Prodotto	Dimensioni	Peso	Capacità Statica	Capacità Dinamica
Pallet My-A 1135x1135	1135x1135xh140 1135x1135xh148 con bordo	9,25 Kg (30 560 300)	4000 kg	1200 kg
Pallet My-A Bis 1135x1135	1135x1135xh165 1135x1135xh173 con bordo	12,25 Kg (82 560 800)	4000 kg	1200 kg

### Dati Logistici

Prodotto	20' DV	40' DV	40' HC	45' WB
Pallet My-A 1135x1135	500 pz.	1000 pz.	1200 pz.	1320 pz.
Pallet My-A Bis 1135x1135	168 pz.	378 pz.	414 pz.	460 pz.

# PALLET / PALLETS

LOGISTICA E MOVIMENTAZIONE / LOGISTICS AND HANDLING

## PALLET CON TRAVETTE

### MY-E





**Carico pesante.** I Pallet monoblocco My-E hanno il pianale e le traversine costampate in un corpo unico. Tre barre di acciaio possono essere inserite nelle tre travette.

**Heavy payloads.** The My-E Pallets have the loading plate and the sleepers moulded in one piece. The sleepers side wall are perfectly vertical.

#### My-E 800x1200 \*



Codice Prodotto





-  **83 560 031** / PE / h150
-  **83 560 032** / RPE / h150
-  **83 560 033** / PE / h157 con bordo
-  **83 560 034** / RPE / h157 con bordo
-  **Prodotto Personalizzabile**



#### My-E 800x1200 con tre barre \*



Codice Prodotto

-  **83 560 035** / PE / h150
-  **83 560 036** / RPE / h150
-  **83 560 037** / PE / h157 con bordo
-  **83 560 038** / RPE / h157 con bordo
-  **Prodotto Personalizzabile**





**30 827 502** Barra in metallo



#### Dati Tecnici

Prodotto	Dimensioni	Peso	Capacità Statica	Capacità Dinamica	Capacità su Rack
Pallet My-E 800x1200	800x1200xh150 800x1200xh157 con bordo	11,0 Kg (83 560 032)	4000 kg	1000 kg	400 kg
Pallet My-E 800x1200 con tre barre	800x1200xh150 800x1200xh157 con bordo	13,9 Kg (83 560 036)	4000 kg	1000 kg	800 kg

#### Dati Logistici

Prodotto	 20' DV	 40' DV	 40' HC	 45' WB
Pallet My-E 800x1200	143 pz.	325 pz.	400 pz.	528 pz.
Pallet My-E 800x1200 con tre barre	143 pz.	325 pz.	400 pz.	528 pz.

\* ADATTO A RACK CON CARICO UNIFORMEMENTE DISTRIBUITO



#### E-SHOP





Scannerizza il QR CODE per accedere direttamente alla pagina ufficiale dello store online.

Scan the QR CODE to directly access the official page of the online store.

#### My-E 1000x1200 \*



Codice Prodotto





-  **83 560 039** / PE / h160
-  **83 560 040** / RPE / h160
-  **83 560 041** / PE / h167 con bordo
-  **83 560 042** / RPE / h167 con bordo
-  **Prodotto Personalizzabile**



#### My-E 1000x1200 con tre barre \*



Codice Prodotto

-  **83 560 043** / PE / h160
-  **83 560 044** / RPE / h160
-  **83 560 045** / PE / h167 con bordo
-  **83 560 046** / RPE / h167 con bordo
-  **Prodotto Personalizzabile**





**30 827 502** Barra in metallo



#### Dati Tecnici

Prodotto	Dimensioni	Peso	Capacità Statica	Capacità Dinamica	Capacità su Rack
Pallet My-E 1000x1200	1000x1200xh160 1000x1200xh167 con bordo	13,4 Kg (83 560 040)	4500 kg	1500 kg	500 kg
Pallet My-E 1000x1200 con tre barre	1000x1200xh160 1000x1200xh167 con bordo	16,3 Kg (83 560 044)	4500 kg	1500 kg	900 kg

#### Dati Logistici

Prodotto	 20' DV	 40' DV	 40' HC	 45' WB
Pallet My-E 1000x1200	130 pz.	286 pz.	352 pz.	416 pz.
Pallet My-E 1000x1200 con tre barre	130 pz.	286 pz.	352 pz.	416 pz.

\* ADATTO A RACK CON CARICO UNIFORMEMENTE DISTRIBUITO

# PALLET / PALLETS

LOGISTICA E MOVIMENTAZIONE / LOGISTICS AND HANDLING

## PALLET CON TRAVETTE

### MY-P

**Carico pesante.** Strutturato per carichi particolarmente pesanti, questo modello è idoneo per utilizzo su rack fino a 1.000 Kg. Il pianale e le travette sono costampati in un corpo unico.

**Heavy payloads.** This model is structured to work with particularly heavy payloads and is suitable for use on racks up to Kg 1,000. The payload surface and beams are moulded together in a single shot.

My-P 600x800 \*



Codice Prodotto

● 83 560 029 / RPE / 3 travi / h160

● Prodotto Personalizzabile



My-P 1000x1200 \*



Codice Prodotto

● 83 560 030 / RPE / 3 travi - pianale liscio / h160

● Prodotto Personalizzabile



### E-SHOP

Scannerizza il QR CODE per accedere direttamente alla pagina ufficiale dello store online.  
Scan the QR CODE to directly access the official page of the online store.

### Dati Tecnici

Prodotto	Dimensioni	Peso	Capacità Statica	Capacità Dinamica	Capacità su Rack
Pallet My-P 600x800	600x800xh160	8,7 Kg	2000 kg	1000 kg	500 kg
Pallet My-P 1000x1200	1000x1200xh160	18,0 Kg	5000 kg	1500 kg	1000 kg

\* ADATTO A RACK CON CARICO UNIFORMEMENTE DISTRIBUITO

## PALLET / PALLETS

LOGISTICA E MOVIMENTAZIONE / LOGISTICS AND HANDLING

### PIANALE/COPERCHIO

Il pianale per pallet è completamente chiuso e liscio e si adatta a qualsiasi pallet 800x1200. Può essere impiegato come coperchio per carico su bancale.

**Flat / Cover.** The flat for pallet is totally closed and smooth, adapts to all 800x1200 pallets. It can also be used as top / cover for goods loaded on a pallet.

#### Pianale / Coperchio per Pallet



Codice Prodotto



30 560 018 / RPP



30 560 018N / PE

Adatto a tutti i tipi di pallet 800x1200



Prodotto Personalizzabile



PIANALE  
COPERCHIO



PIATTAFORMA  
GRIGLIATA

#### E-SHOP

Scannerizza il QR CODE per accedere direttamente alla pagina ufficiale dello store online.  
Scan the QR CODE to directly access the official page of the online store.

### PIATTAFORMA GRIGLIATA

La piattaforma è una soluzione ottimale per ottenere pavimentazioni facilmente rimovibili.

**Grated platform.** The platform is an excellent solution for creating easily removable flooring.

#### Piattaforma grigliata

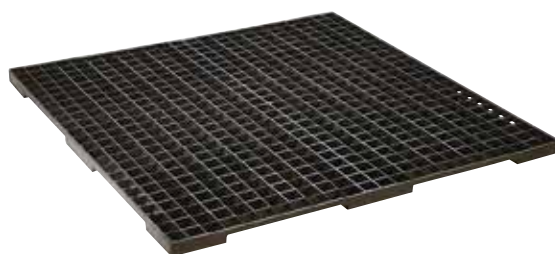

Codice Prodotto



30 560 082 / RPP / h40



Prodotto Personalizzabile

#### Dati Tecnici

Prodotto	Dimensioni	Peso	Informazioni aggiuntive	Capacità Statica
Pianale / Coperchio per Pallet	820x1220xh35	4,1 Kg (30 560 018)	Adatto a tutti i tipi di Pallet 800x1200	-
Piattaforma grigliata	1200x1200xh40	9,6 Kg	-	4000 kg

# PALLET / PALLETS

LOGISTICA E MOVIMENTAZIONE / LOGISTICS AND HANDLING

## TUTTE LE RAGIONI PER SCEGLIERLI

- 1 Robusti.** La capacità statica raggiunge i 4.000 kg e la capacità dinamica i 1.500 kg.
  - 2 Elettroisolanti.** L'intera gamma assicura un ottimo isolamento elettrico.
  - 3 Leggeri.** La movimentazione è estremamente pratica ed agevole.
  - 4 Tara costante.** È possibile l'utilizzo in impianti di imballaggio computerizzati.
  - 5 Ecologici.** I Pallet della Martini Alfredo S.p.A. sono completamente riciclabili e riutilizzabili.
  - 6 Lavabili.** Pulizia e manutenzione sono semplicissime.
  - 7 Idonei per alimenti.** Sono anche disponibili le versioni ad uso alimentare.
  - 8 Resistenti all'umidità.** A differenza dei pallet in legno, resistono ad acqua e umidità.
  - 9 Inattaccabili da agenti chimici.** La resina sintetica non viene corrosa da acidi e solventi.
- 1 Robust.** Can hold with a static load of up to 4,500 kg and a dynamic load of up to 1,500 kg.
  - 2 Electrical insulation.** The entire range guarantees excellent electrical insulation.
  - 3 Lightweight.** Light weight makes all handling operations extremely practical and straightforward.
  - 4 Constant calibration.** Can be used in computerised packaging systems.
  - 5 Environmentally friendly.** Martini Alfredo S.p.A. pallets are completely recyclable and reusable.
  - 6 Washable.** Cleaning and maintenance are very easy.
  - 7 Suitable for foodstuffs.** Versions for use with foodstuffs are also available.
  - 8 Resistant to damp.** Unlike wooden pallets, Martini Alfredo S.p.A. pallets are resistant to water and dampness.
  - 9 Immune to chemical agents.** This synthetic resin is not corroded by acids and solvents.

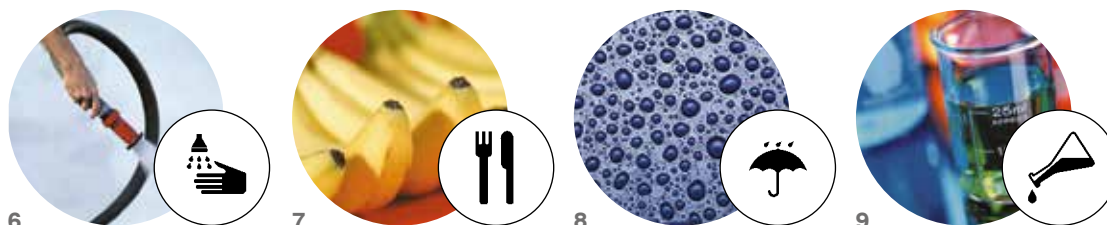

## CONTENITORI MULTIUSO

*Organizzazione perfetta, stoccaggio ottimale*

## MULTIPLE USE CONTAINERS

*Perfect organization, optimum storage*

Questa vasta famiglia di contenitori assicura la massima versatilità di utilizzo, con soluzioni ad hoc per specifiche necessità di movimentazione e stoccaggio.

This extensive family of containers ensures maximum versatility in use, with proper solutions for specific requirements as handling and storing.



- 34 **Alfa**
- 38 **Delta**
- 40-47 **Delta Mec**
- 48 **Delta Mec Fold**
- 49 **Delta Mec 60L / Delta Mec 70 Open**
- 50 **Delta Mec Misure Speciali**
- 51 **Pettini e Divisori**
- 52 **Coperchi e accessori Delta Mec**
- 54 **Omikron**
- 57 **Tauxi**
- 58 **Tau**
- 60 **Cassonetti Carrellati**
- 61 **Jota**
- 62 **Lambda**
- 63 **Contenitori isotermitici**
- 64 **Gamma**
- 66 **Cestelli**



# CONTENITORI MULTIUSO / MULTIPLE USE CONTAINERS

ORGANIZZAZIONE E STOCCAGGIO / ORGANIZATION AND STORAGE

COMPONIBILI AUTOPORTANTI

## ALFA

Contenitori multicomponibili autoportanti a bocca di lupo, ideali per il prelievo manuale del contenuto nei magazzini e nelle catene di montaggio.

Self-supporting multiple use containers, the open side is ideal for the manual picking of the goods in the workshops and on assembly lines.

### Alfa 1



Codice Prodotto

 30 185 200

Dimensioni esterne	Dimensioni interne	Peso
102x88xh50	90x78xh42	 0,037 Kg



### Alfa 2



Codice Prodotto

 30 185 220

 30 185 224

 30 185 226

 30 185 229

Dimensioni esterne	Dimensioni interne	Peso
103x173xh74	85x147xh65	 0,095 Kg



### Alfa 3



Codice Prodotto

 30 185 240

 30 185 244

 30 185 246

 30 185 250

Dimensioni esterne	Dimensioni interne	Peso
144x235xh116	123x203xh103	 0,24 Kg



# CONTENITORI MULTIUSO / MULTIPLE USE CONTAINERS

ORGANIZZAZIONE E STOCCAGGIO / ORGANIZATION AND STORAGE

COMPONIBILI AUTOPORTANTI



## E-SHOP

Scannerizza il QR CODE per accedere direttamente alla pagina ufficiale dello store online.

Scan the QR CODE to directly access the official page of the online store.

### Alfa 4



Codice Prodotto

30 185 260

30 185 264

30 185 266

30 185 270

Dimensioni esterne	Dimensioni interne	Peso
207x335xh150	178x290xh138	0,43 Kg



### Alfa 5



Codice Prodotto

30 185 280

30 185 284

30 185 286

30 185 292

30 185 288

Dimensioni esterne	Dimensioni interne	Peso
307x480xh185	275x430xh170	1,18 Kg



### Alfa 5 Bis



Codice Prodotto

30 185 300

30 185 308

Dimensioni esterne	Dimensioni interne	Peso
307x480xh185	275x430xh170	1,48 Kg



Grandi Contenitori  
Large Containers

Pallet  
Pallets

Contenitori multiuso  
Multiple use containers

Contenitori Detectabili  
Detectable Containers

Cassettiere e Scaffalature  
Drawers and Shelves

Pavimentazioni Componibili  
Floor mat elements

# CONTENITORI MULTIUSO / MULTIPLE USE CONTAINERS

ORGANIZZAZIONE E STOCCAGGIO / ORGANIZATION AND STORAGE

COMPONIBILI AUTOPORTANTI

Grandi Contenitori  
Large Containers

Pallet  
Pallets

Contenitori multiuso  
Multiple use containers

Contenitori Detectabili  
Detectable Containers

Cassettiere e Scaffalature  
Drawers and Shelves

Pavimentazioni Componibili  
Floor mat elements



## E-SHOP

Scannerizza il QR CODE per accedere direttamente alla pagina ufficiale dello store online.

Scan the QR CODE to directly access the official page of the online store.

### Alfa 6



Codice Prodotto

30 185 320

30 185 324

Dimensioni esterne	Dimensioni interne	Peso
437x570xh247	397x510xh228	2,08 Kg



### Alfa 6 Bis



Codice Prodotto

30 185 330

30 185 334

Dimensioni esterne	Dimensioni interne	Peso
437x570xh247	397x510xh228	2,43 Kg



### Alfa 7



Codice Prodotto

30 185 340

30 185 344

Dimensioni esterne	Dimensioni interne	Peso
437x700xh301	397x640xh280	2,7 Kg



# CONTENITORI MULTIUSO / MULTIPLE USE CONTAINERS

ORGANIZZAZIONE E STOCCAGGIO / ORGANIZATION AND STORAGE

COMPONIBILI AUTOPORTANTI



## E-SHOP

Scannerizza il QR CODE per accedere direttamente alla pagina ufficiale dello store online.

Scan the QR CODE to directly access the official page of the online store.

### Alfa 7 Bis



Codice Prodotto

 30 185 350

 30 185 354

Dimensioni esterne	Dimensioni interne	Peso
437x700xh301	397x640xh280	 3,7 Kg



## ACCESSORI ALFA

Per i modelli ALFA 5, 5 bis, 6, 6 bis, 7, 7 bis sono disponibili specifici carrelli per agevolare la movimentazione.

Alfa Accessories. Specific trolleys are available for the ALFA 5, 5 bis, 6, 6 bis, 7, 7 bis models.

### Accessori



Carrelli



Etichette



Barra Rack

Codice Prodotto

#### Carrelli

30 130 510 / Alfa 5 e 5 Bis per 2 contenitori 615x440xh185

30 130 512 / Alfa 6 e 6 Bis per 2 contenitori 880x485xh185

30 130 514 / Alfa 7 e 7 Bis per 2 contenitori 880x610xh185

#### Etichette

30 838 60x / Alfa 2 foglio da 50 etichette

30 838 61x / Alfa 3, 4, 5, 5 Bis foglio da 21 etichette

30 838 62x / Alfa 6, 6 Bis, 7, 7 Bis foglio da 7 etichette

#### Barra Rack

30 827 501 / Senza contenitori 930x200xh10

Grandi Contenitori  
Large Containers

Pallet  
Pallets

Contenitori multiuso  
Multiple use containers

Contenitori Detectabili  
Detectable Containers

Cassettiere e Scaffalature  
Drawers and Shelves

Pavimentazioni Componibili  
Floor mat elements

# CONTENITORI MULTIUSO / MULTIPLE USE CONTAINERS

ORGANIZZAZIONE E STOCCAGGIO / ORGANIZATION AND STORAGE

SOVRAPPONIBILI

## DELTA

Contenitori sovrapponibili, con maniglie, adatti a minuteria meccanica e prodotti farmaceutici. Anche in materiale atossico o in materiale conduttivo.



Stackable containers with handles, suitable for small metal products and pharmaceuticals. Also available in non-toxic material or in conductive plastic.

### Delta 20



Codice Prodotto

-  30 185 400
-  30 185 406
-  30 185 403
-  Prodotto Personalizzabile

Dimensioni esterne	Dimensioni interne	Peso
447x314xh200	375x275xh195	 1,13 Kg
		 1,24 Kg





### Delta 21



Codice Prodotto

-  30 185 410
-  Prodotto Personalizzabile
-  30 185 416

Dimensioni esterne	Dimensioni interne	Peso
400x300xh257	325x260xh254	 1,3 Kg
		 1,38 Kg





### Delta 30



Codice Prodotto

-  30 185 420
-  Prodotto Personalizzabile
-  30 185 423

Dimensioni esterne	Dimensioni interne	Peso
510x415xh195	440x375xh190	 1,43 Kg
		 1,5 Kg



# CONTENITORI MULTIUSO / MULTIPLE USE CONTAINERS

ORGANIZZAZIONE E STOCCAGGIO / ORGANIZATION AND STORAGE

SOVRAPPONIBILI

Grandi Contenitori  
Large Containers



## E-SHOP

Scannerizza il QR CODE per accedere direttamente alla pagina ufficiale dello store online.

Scan the QR CODE to directly access the official page of the online store.

Delta 60



Codice Prodotto



30 185 440



Prodotto Personalizzabile



30 185 443

Dimensioni esterne	Dimensioni interne	Peso
610x425xh300	535x365xh290	2,54 Kg
		2,84 Kg



Pallet  
Pallets

Contenitori multiuso  
Multiple use containers

## ACCESSORI DELTA

Accessori



Carrelli



Coperchi



Portaetichette

Codice Prodotto

Carrelli

30 130 530 / Delta 20 410x315xh125

30 130 532 / Delta 21 360x300xh125

30 130 535 / Delta 30 460x395xh125

30 130 538 / Delta 60 590x420xh180

Coperchi

32 194 730 / Delta 20 457x320xh25

32 194 740 / Delta 30 515x420xh20

32 194 750 / Delta 60 610x435xh20

30 194 607 / Delta 21 408x310xh15

Portaetichette

30 005 631 / 195x5xh100

30 005 632 / 195x5xh100

Contenitori Detectabili  
Detectable Containers

Cassettiere e Scaffalature  
Drawers and Shelves

Pavimentazioni Componibili  
Floor mat elements

# CONTENITORI MULTIUSO / MULTIPLE USE CONTAINERS

ORGANIZZAZIONE E STOCCAGGIO / ORGANIZATION AND STORAGE

SOVRAPPONIBILI

## MINI DELTA MEC 300x200

Contenitori sovrapponibili utilizzati nei processi di movimentazione e stoccaggio nell'industria orafa e per il trasporto di materiali e componenti preziosi e/o delicati. Coperchio a slitta sigillabile.

Stackable bins. They are particularly suitable for the gold and precious materials handling. Sliding and sealable lid.



### E-SHOP

Scannerizza il QR CODE per accedere direttamente alla pagina ufficiale dello store online.

Scan the QR CODE to directly access the official page of the online store.

### Mini Delta Mec 90



Codice Prodotto

80 230 260

Prodotto Personalizzabile



### Mini Delta Mec 120



Codice Prodotto

80 230 261

Prodotto Personalizzabile



### Dati Tecnici

Pareti piene, fondo pieno, maniglie chiuse, coperchio a slitta sigillabile.

Prodotto	Dimensioni esterne	Dimensioni interne	Peso
Mini Delta Mec 90	300x200xh90	265x165xh85	0,335 Kg
Mini Delta Mec 120	300x200xh120	265x165xh115	0,355 Kg

# CONTENITORI MULTIUSO / MULTIPLE USE CONTAINERS

ORGANIZZAZIONE E STOCCAGGIO / ORGANIZATION AND STORAGE

SOVRAPPONIBILI

## Mini Delta Mec 140



Codice Prodotto



80 230 262



Prodotto Personalizzabile



## Mini Delta Mec 170



Codice Prodotto



80 230 263



Prodotto Personalizzabile



## Mini Delta Mec 220



Codice Prodotto



80 230 264



Prodotto Personalizzabile



### Dati Tecnici

Pareti piene, fondo pieno, maniglie chiuse, coperchio a slitta sigillabile.

Prodotto	Dimensioni esterne	Dimensioni interne	Peso
Mini Delta Mec 140	300x200xh140	265x165xh135	0,410 Kg
Mini Delta Mec 170	300x200xh170	265x165xh165	0,445 Kg
Mini Delta Mec 220	300x200xh220	265x165xh215	0,555 Kg

# CONTENITORI MULTIUSO / MULTIPLE USE CONTAINERS

ORGANIZZAZIONE E STOCCAGGIO / ORGANIZATION AND STORAGE

SOVRAPPONIBILI

## DELTA MEC 400x300

Contenitori ultrarobusti, in materiale antiurto inattaccabile da acidi e solventi. Con coperchio in appoggio o a slitta, fondo pieno o alveolare.

Ultra-sturdy containers made of shockproof material inert to acids and solvents and resistant to damp. With a lid that sits on or slides onto the top.



### E-SHOP

Scannerizza il QR CODE per accedere direttamente alla pagina ufficiale dello store online.

Scan the QR CODE to directly access the official page of the online store.

### Delta Mec 3



Codice Prodotto



80 230 230



Prodotto Personalizzabile



### Delta Mec 6



Codice Prodotto



80 230 240



Prodotto Personalizzabile



### Dati Tecnici

Pareti piene, fondo pieno, maniglie chiuse. \* Fondo alveolare

Prodotto	Dimensioni esterne	Dimensioni interne	Peso
Delta Mec 3	400x300xh40	365x262xh30	0,475 Kg
Delta Mec 6	400x300xh70	365x262xh60	0,645 Kg

# CONTENITORI MULTIUSO / MULTIPLE USE CONTAINERS

ORGANIZZAZIONE E STOCCAGGIO / ORGANIZATION AND STORAGE

SOVRAPPONIBILI

## Delta Mec 9



Codice Prodotto

80 230 250

Prodotto Personalizzabile



## Delta Mec 12



Codice Prodotto

80 230 051

Prodotto Personalizzabile



## Delta Mec 17



Codice Prodotto

80 230 183

Prodotto Personalizzabile



### Dati Tecnici

Pareti piene, fondo pieno, maniglie chiuse. \* Fondo alveolare

Prodotto	Dimensioni esterne	Dimensioni interne	Peso
Delta Mec 9	400x300xh100	365x262xh90	0,765 Kg
Delta Mec 12*	400x300xh140	365x262xh130	1,0 Kg
Delta Mec 17*	400x300xh170	365x262xh160	1,1 Kg

# CONTENITORI MULTIUSO / MULTIPLE USE CONTAINERS

ORGANIZZAZIONE E STOCCAGGIO / ORGANIZATION AND STORAGE

SOVRAPPONIBILI

## Delta Mec 22



Codice Prodotto



80 230 182



Prodotto Personalizzabile



## Delta Mec 32



Codice Prodotto



80 230 191



Prodotto Personalizzabile



## Cornice per Delta Mec 400x300



Codice Prodotto



80 230 223



Prodotto Personalizzabile



### Dati Tecnici

Pareti piene, fondo pieno, maniglie chiuse. \* Fondo alveolare

Prodotto	Dimensioni esterne	Dimensioni interne	Peso
Delta Mec 22*	400x300xh220	365x262xh210	1,33 Kg
Delta Mec 32*	400x300xh320	365x262xh310	1,71 Kg
Cornice Delta Mec 400x300	400x300xh75	355x255xh75 (altezza utile: 60 mm)	0,37 Kg

# CONTENITORI MULTIUSO / MULTIPLE USE CONTAINERS

ORGANIZZAZIONE E STOCCAGGIO / ORGANIZATION AND STORAGE

SOVRAPPONIBILI

## DELTA MEC 600x400

Contenitori antiurto, sovrapponibili, con maniglie passanti o chiuse, pareti verticali, sono adatti anche ai magazzini automatici.

Shockproof containers, stackable, with open or closed handles, vertical walls, they are suitable also for automatic warehouses.

### Delta Mec 25



Codice Prodotto

80 230 177

Prodotto Personalizzabile



### Delta Mec 30



Codice Prodotto

80 230 075

Prodotto Personalizzabile



### E-SHOP

Scannerizza il QR CODE per accedere direttamente alla pagina ufficiale dello store online.  
Scan the QR CODE to directly access the official page of the online store.

#### Dati Tecnici

Pareti piene, fondo alveolare, maniglie chiuse.

Prodotto	Dimensioni esterne	Dimensioni interne	Peso
Delta Mec 25	600x400xh140	565x360xh130	1,55 Kg
Delta Mec 30	600x400xh170	565x360xh160	1,87 Kg

# CONTENITORI MULTIUSO / MULTIPLE USE CONTAINERS

ORGANIZZAZIONE E STOCCAGGIO / ORGANIZATION AND STORAGE

SOVRAPPONIBILI

## Delta Mec 35



Codice Prodotto



80 230 077



Prodotto Personalizzabile



## Delta Mec 40



Codice Prodotto



80 230 079



Prodotto Personalizzabile



## Delta Mec 45



Codice Prodotto



80 230 081



Prodotto Personalizzabile



### Dati Tecnici

Pareti piene, fondo alveolare, maniglie chiuse.

Prodotto	Dimensioni esterne	Dimensioni interne	Peso
Delta Mec 35	600x400xh200	565x360xh190	2,035 Kg
Delta Mec 40	600x400xh220	565x360xh210	2,035 Kg
Delta Mec 45	600x400xh240	565x360xh230	2,175 Kg

# CONTENITORI MULTIUSO / MULTIPLE USE CONTAINERS

ORGANIZZAZIONE E STOCCAGGIO / ORGANIZATION AND STORAGE

SOVRAPPONIBILI

## Delta Mec 50



Codice Prodotto



80 230 083



Prodotto Personalizzabile



## Delta Mec 60



Codice Prodotto



80 230 132



Prodotto Personalizzabile



## Delta Mec 70



Codice Prodotto



80 230 210



80 230 207 / con fori di drenaggio



Prodotto Personalizzabile



### Dati Tecnici

Pareti piene, fondo alveolare, maniglie chiuse. \* Con maniglie passanti

Prodotto	Dimensioni esterne	Dimensioni interne	Peso
Delta Mec 50	600x400xh275	565x360xh265	2,01 Kg
Delta Mec 60	600x400xh320	565x360xh310	2,55 Kg
Delta Mec 70*	600x400xh400	565x360xh390	3,24 Kg

# CONTENITORI MULTIUSO / MULTIPLE USE CONTAINERS

ORGANIZZAZIONE E STOCCAGGIO / ORGANIZATION AND STORAGE

SOVRAPPONIBILI

## DELTA MEC FOLD

I contenitori Delta Mec Fold sono ideali nella logistica e nel trasporto con ritorno dei vuoti. Facili da aprire e richiudere, sono disponibili in otto diverse versioni con fondo liscio o rinforzato e con coperchio integrato.

Shockproof containers, stackable, with open or closed handles, vertical walls, they are suitable also for automatic warehouses.

### Delta Mec Fold 40



Codice Prodotto

- 83 230 001 / Fondo liscio
- 83 230 002 / Fondo liscio e coperchio
- 83 230 003 / Fondo rinforzato
- 83 230 004 / Fondo rinforzato e coperchio
- Prodotto Personalizzabile



### Delta Mec Fold 60



Codice Prodotto

- 83 230 010 / Fondo liscio
- 83 230 011 / Fondo liscio e coperchio
- 83 230 012 / Fondo rinforzato
- 83 230 013 / Fondo rinforzato e coperchio
- Prodotto Personalizzabile



### E-SHOP

Scannerizza il QR CODE per accedere direttamente alla pagina ufficiale dello store online.

Scan the QR CODE to directly access the official page of the online store.

### Dati Tecnici

Prodotto	Dimensioni esterne	Dimensioni interne	Peso
Delta Mec Fold 40	600x400xh223	560x362xh205	2,4 Kg (83 230 002)
Delta Mec Fold 60	600x400xh320	558x362xh304	3,3 Kg (83 230 011)

# CONTENITORI MULTIUSO / MULTIPLE USE CONTAINERS

ORGANIZZAZIONE E STOCCAGGIO / ORGANIZATION AND STORAGE

SOVRAPPONIBILI

## DELTA MEC 60L

Specifico per impianti automatizzati. Fino a 50 Kg di merce senza deformazioni del fondo, ha maniglie ergonomiche ed è dotato di prese robotizzate.

Specifically designed for automatic installations. Up to 50 Kg with no bottom deformation, has ergonomic handles and is fitted with robotic grips.

### Delta Mec 60L



Fondo rinforzato.  
Indeformabile e resistente



Le maniglie ergonomiche agevolano gli spostamenti manuali.

Codice Prodotto



80 230 351 / Fondo pieno



80 230 353 / Fondo pieno con fori di drenaggio



80 230 350 / Fondo rinforzato



80 230 352 / Fondo rinforzato con fori di drenaggio



Prodotto Personalizzabile



DELTA MEC  
60L



DELTA MEC  
70 OPEN

### E-SHOP

Scannerizza il QR CODE per accedere direttamente alla pagina ufficiale dello store online.  
Scan the QR CODE to directly access the official page of the online store.

## DELTA MEC 70 OPEN

Questa versione offre sia la sovrapponibilità e l'adattabilità agli impianti automatizzati che l'accessibilità manuale al contenuto.

This version is stackable and therefore suitable for the automatic installations, and offers as a plus the open side for easy picking of the goods.

### Delta Mec 70 Open



Codice Prodotto



80 230 206



80 230 205 / con fori di drenaggio



Prodotto Personalizzabile



### Dati Tecnici

\* Pareti piene, maniglie chiuse / \*\* Pareti piene, fondo alveolare, maniglia passante

Prodotto	Dimensioni esterne	Dimensioni interne	Peso
Delta Mec 60 L fondo pieno *	600x400xh320	565x360xh300	2,82 Kg (80 230 351)
Delta Mec 60 L fondo rinforzato *	600x400xh320	565x360xh315	3,45 Kg (80 230 350)
Delta Mec 70 Open **	600x400xh400	565x360xh390	3,22 Kg (80 230 206)

# CONTENITORI MULTIUSO / MULTIPLE USE CONTAINERS

ORGANIZZAZIONE E STOCCAGGIO / ORGANIZATION AND STORAGE

SOVRAPPONIBILI

## DELTA MEC Misure Speciali

Le speciali dimensioni ampliano le possibilità d'uso della linea Delta Mec.

This product's special dimensions expands the possibilities to use the Delta Mec collection.



### E-SHOP

Scannerizza il QR CODE per accedere direttamente alla pagina ufficiale dello store online.

Scan the QR CODE to directly access the official page of the online store.

### Delta Mec Misure Speciali



Delta Mec 75



Delta Mec 80



Delta Mec 85F



Delta Mec 100F



Delta Mec 200F

Codice Prodotto

- 80 230 301** / Delta Mec 75
- 80 230 310** / Delta Mec 80
- 30 185 054** / Delta Mec 100F
- 30 185 055** / Delta Mec 200F
- 30 185 056** / Delta Mec 85F
- Prodotto Personalizzabile**



### Dati Tecnici

\* Pareti forate, fondo forato, maniglie passanti. \*\* Pareti chiuse, fondo rinforzato, maniglie passanti.

Prodotto	Dimensioni esterne	Dimensioni interne	Peso
Delta Mec 75 *	600x500 h250	570x470xh245	3,0 Kg
Delta Mec 80 *	610x520 h260	580x490xh255	3,1 Kg
Delta Mec 85F **	820x620 h170	785/791x585/591xh150	3,8 Kg
Delta Mec 100F **	620x420 h400	585/590x385/390xh380	3,65 Kg
Delta Mec 200F **	820x620 h400	785/790x585/591xh380	6,25 Kg

## PETTINI e DIVISORI

Ottimizzano lo stoccaggio della serie Delta Mec. Il volume interno di carico può essere ripartito in vani di diverse dimensioni.

Combs dividers. Optimize the storage of the Delta Mec containers series. The inner volume can be organized into compartments.

### Pettini e Divisori



Codice Prodotto

#### Pettini divisori

- 32 194 400 interno 1150x5 h40
- 32 194 401 interno 1150x5 h80
- 32 194 402 interno 1150x5 h100
- 32 194 403 interno 1150x5 h120
- 32 194 404 interno 1150x5 h180
- 32 194 431 per Mini Delta Mec 300x200 / 160x5 h40
- 32 194 432 per Mini Delta Mec 300x200 / 160x5 h80
- 32 194 433 per Mini Delta Mec 300x200 / 160x5 h100
- 32 194 434 per Mini Delta Mec 300x200 / 160x5 h120
- 32 194 435 per Mini Delta Mec 300x200 / 160x5 h180
- 32 194 410 per Mini Delta Mec 300x200 e 400x300 / 260x5 h40
- 32 194 411 per Delta Mec 400x300 e 600x400 / 360x5 h40
- 32 194 412 per Delta Mec 600x400 / 560x5 h40
- 32 194 413 per Mini Delta Mec 300x200 e 400x300 / 260x5 h80
- 32 194 414 per Delta Mec 400x300 e 600x400 / 360x5 h80
- 32 194 415 per Delta Mec 600x400 / 560x5 h80
- 32 194 416 per Mini Delta Mec 300x200 e 400x300 / 260x5 h100
- 32 194 417 per Delta Mec 400x300 e 600x400 / 360x5 h100
- 32 194 418 per Delta Mec 600x400 / 560x5 h100
- 32 194 419 per Mini Delta Mec 300x200 e 400x300 / 260x5 h120
- 32 194 420 per Delta Mec 400x300 e 600x400 / 360x5 h120
- 32 194 421 per Delta Mec 600x400 / 560x5 h120
- 32 194 429 per Mini Delta Mec 300x200 e 400x300 / 260x5 h180
- 32 194 427 per Delta Mec 400x300 e 600x400 / 360x5 h180
- 32 194 428 per Delta Mec 600x400 / 560x5 h180
- 32 194 406 per Delta Mec / 420x5xh300
- 32 194 407 per Delta Mec / 620x5x300 e 820x5x300
- 32 194 408 per Delta Mec / 820x5x300

#### Ripiani separatori

- 32 194 425 / per Delta Mec 400x300
- 32 194 426 / per Delta Mec 600x400



### E-SHOP

Scannerizza il QR CODE per accedere direttamente alla pagina ufficiale dello store online.  
Scan the QR CODE to directly access the official page of the online store.

# CONTENITORI MULTIUSO / MULTIPLE USE CONTAINERS

ORGANIZZAZIONE E STOCCAGGIO / ORGANIZATION AND STORAGE

SOVRAPPONIBILI E IMPILABILI

## COPERCHI / ACCESSORI e VARIANTI FONDI

### Coperchi e Accessori



Coperchio Mini Delta Mec 300x200



Coperchio Delta Mec 400x300



Coperchio Delta Mec 600x400



Coperchio  
Delta Mec 400x300 / 600x400



Carrello per Delta Mec



Portadocumenti A4/A5  
Delta Mec 600x400 h400



Portatichette



Vaschette portaposate

### Varianti Fondi



**Fondo forato**  
Per aerazione interna



**Fondo pieno**  
Per i modelli più piccoli



**Fondo alveolare**  
Indeformabile e resistente



**Per Delta Mec 60L  
Fondo liscio**  
Igienico e antirumore

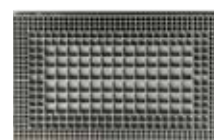

**Per Delta Mec 60L  
Fondo rinforzato**  
Per carichi gravosi

Codice Prodotto

#### Mini Delta Mec 300x200

 **30 194 609** / 308x210 h19 a slitta sigillabile

#### Delta Mec 400x300

 **30 194 601** / 400x300xh22

 **30 194 607** / 408x310 h19 a slitta sigillabile

 **30 194 601AI** / 400x300xh22 con cerniere integrate

#### Delta Mec 600x400

 **30 194 605** / 600x400xh21

 **30 194 618** / 604x407xh19 a slitta sigillabile

 **30 194 605AI** / 600x400xh21 con cerniere integrate

#### Per Delta Mec 400x300 / 600x400

**30 194 647** / sistema di chiusura a mezzo di 2 mollette, non montano

**30 005 648** / sistema di chiusura a mezzo di 2 mollette, montano

#### Carrello per Delta Mec

**32 130 585** / 620x420xh170

Utilizzabile per 1 Delta Mec 600x400 o per 2 Delta Mec 400x300

#### Portadocumenti A4/A5 Delta Mec 600x400 h400

**30 005 650A** / 295x215xh10

#### Portatichette

**30 005 638** / 150x7xh85 per Delta Mec 12/70

#### Vaschette portaposate

**53 190 500** / 264x90 h60 vaschetta

**53 190 600** / 85x2xh54 separatore



# CONTENITORI MULTIUSO / MULTIPLE USE CONTAINERS

ORGANIZZAZIONE E STOCCAGGIO / ORGANIZATION AND STORAGE

SOVRAPPONIBILI E IMPILABILI

## OMIKRON

Contenitori adatti alla movimentazione ed allo stoccaggio. Resistenti a temperature tra -10°C e 100°C. Sono inseribili e vuoti riducono gli ingombri.

Containers suitable for handling and storing. Resistant to temperatures from -10°C to 100°C. They are nestable and when empty occupy less space.



### E-SHOP

Scannerizza il QR CODE per accedere direttamente alla pagina ufficiale dello store online.

Scan the QR CODE to directly access the official page of the online store.

#### Omikron 6



Codice Prodotto

● 30 185 600



#### Omikron 70



Codice Prodotto

● 30 185 610 / senza alette

● 30 185 620 / con alette

● 30 185 611 / senza alette

● 30 185 621 / con alette



#### Dati Tecnici

Prodotto	Dimensioni esterne	Dimensioni interne	Peso
Omikron 6	300x200xh165	230/260x130/160xh160	0,385 Kg
Omikron 70	600x400xh410	490/525x325/350xh405	2,915 Kg (30 185 610)

# CONTENITORI MULTIUSO / MULTIPLE USE CONTAINERS

ORGANIZZAZIONE E STOCCAGGIO / ORGANIZATION AND STORAGE

SOVRAPPONIBILI E IMPILABILI

## Omikron 100



Codice Prodotto

-  **30 185 630** / senza alette
-  **30 185 640** / con alette
-  **30 185 631** / senza alette
-  **30 185 641** / con alette



## Omikron 120



Codice Prodotto



-  **30 185 670**



## Omikron 200



Codice Prodotto

-  **30 185 650** / senza alette
-  **30 185 660** / con alette
-  **30 185 652** / senza alette
-  **30 185 662** / con alette



7 Omikron 200 L  
sovrapposti  
= 3820 mm

7 Omikron 200 L  
inseriti  
= 1525 mm

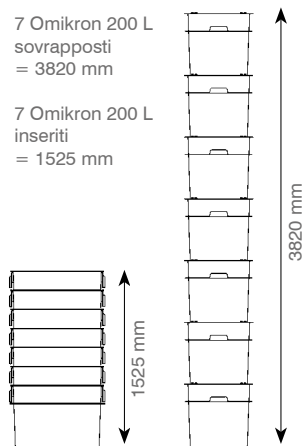

### Dati Tecnici

Prodotto	Dimensioni esterne	Dimensioni interne	Peso
Omikron 100	800x400xh410	700/730x325/350xh405	3,12 Kg (30 185 630)
Omikron 120	780x375xh560	695/735x280/315xh555	5,1 Kg
Omikron 200	800x600xh550	675/730x490/540xh545	7,6 Kg (30 185 650)

Grandi Contenitori  
Large Containers

Pallet  
Pallets

Contenitori multiuso  
Multiple use containers

Contenitori Detectabili  
Detectable Containers

Cassettiere e Scaffalature  
Drawers and Shelves

Pavimentazioni Componibili  
Floor mat elements

# CONTENITORI MULTIUSO / MULTIPLE USE CONTAINERS

ORGANIZZAZIONE E STOCCAGGIO / ORGANIZATION AND STORAGE

ACCESSORI



## E-SHOP

Scannerizza il QR CODE per accedere direttamente alla pagina ufficiale dello store online.

Scan the QR CODE to directly access the official page of the online store.

### Coperchi



Codice Prodotto

- 30 194 615** / Omikron 6 a slitta sigillabile / 305x205 h20
- 30 194 610** / Omikron 70 / 610x410xh16
- 30 194 611** / Omikron 70 / 610x410xh16
- 30 194 620** / Omikron 100 / 810x410xh20
- 30 194 621** / Omikron 100 / 810x410xh20
- 30 194 630** / Omikron 200 / 805x615xh45
- 30 194 631** / Omikron 200 / 805x615xh45

#### Sistema di chiusura

**30 005 640** / Per coperchi Omikron 70/100

### Alette



Codice Prodotto

- 30 005 030** / Omikron 70/100 395x108xh20
- 30 005 040** / Omikron 200 595x152xh25

### Carrelli



Codice Prodotto

- 30 130 551** / Omikron 70 / 520x350xh185
- 30 130 554** / Omikron 100 / 725x350xh185
- 30 130 557** / Omikron 200 / 710x515xh185

# CONTENITORI MULTIUSO / MULTIPLE USE CONTAINERS

ORGANIZZAZIONE E STOCCAGGIO / ORGANIZATION AND STORAGE

SOVRAPPONIBILI E IMPILABILI

## TAUXI

I contenitori TAUXI sono ideali per la distribuzione organizzata. Con coperchio a “coccodrillo”, sono disponibili in tre diverse misure. Inseribili a coperchio aperto e sovrapponibili a coperchio chiuso.

TAUXI Containers are ideal for retail chains. They are equipped with a “crocodile” lid and are available in three different sizes. They are nestable with the open lid and stackable with the closed lid.

Tauxi 46



Codice Prodotto



**32 185 550**

5 Tauxi 46 sovrapposti = 1265 mm  
5 Tauxi 46 inseriti = 590 mm



**Prodotto Personalizzabile**

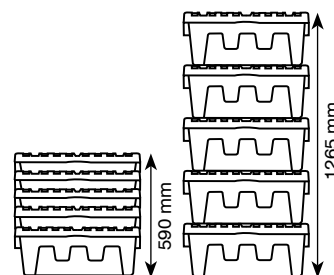

Tauxi 54



Codice Prodotto



**32 185 551**

5 Tauxi 54 sovrapposti = 1515 mm  
5 Tauxi 54 inseriti = 700 mm



**Prodotto Personalizzabile**

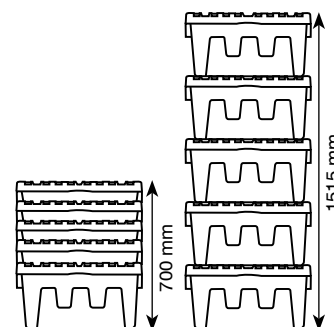

Tauxi 67



Codice Prodotto



**32 185 552**

5 Tauxi 67 sovrapposti = 1765 mm  
5 Tauxi 67 inseriti = 830 mm



**Prodotto Personalizzabile**

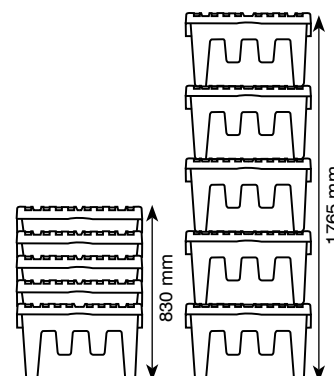

### Dati Tecnici

Prodotto	Dimensioni esterne	Dimensioni interne	Peso
Tauxi 46	600x400xh265	547x365xh237	2,95 Kg
Tauxi 54	600x400xh315	547x365xh287	3,3 Kg
Tauxi 67	600x400xh365	547x365xh337	3,6 Kg

# CONTENITORI MULTIUSO / MULTIPLE USE CONTAINERS

ORGANIZZAZIONE E STOCCAGGIO / ORGANIZATION AND STORAGE

SOVRAPPONIBILI E IMPILABILI

## TAU

Sovrapponibili e impilabili se ruotati di 180°, agevolano lo stoccaggio dei vuoti. Sono perfetti per giornali e riviste e per prodotti farmaceutici.

They are stackable and nestable when spun by 180°, thus easing the empties storage. They are perfect for news papers and for pharmaceutical products.

### Tau 27



Codice Prodotto

30 185 544

Prodotto Personalizzabile



Coperchio Tau 27

30 194 604  
465x350xh18



### Tau 40



Codice Prodotto

30 185 547

Prodotto Personalizzabile



Coperchio Tau 40

30 194 625  
560x390xh30

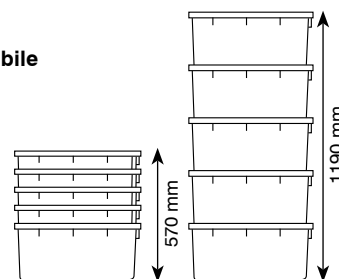

5 Tau 40 sovrapposti = 1190 mm  
5 Tau 40 inseriti = 570 mm



### E-SHOP

Scannerizza il QR CODE per accedere direttamente alla pagina ufficiale dello store online.

Scan the QR CODE to directly access the official page of the online store.

### Dati Tecnici

Prodotto	Dimensioni esterne	Dimensioni interne	Peso
Tau 27	460x345xh245	370/390x285/300xh240	1,17 Kg
Tau 40	550x380xh250	435/475x320/345xh245	1,52 Kg

# CONTENITORI MULTIUSO / MULTIPLE USE CONTAINERS

ORGANIZZAZIONE E STOCCAGGIO / ORGANIZATION AND STORAGE

SOVRAPPONIBILI E IMPILABILI

## Tau 50



Codice Prodotto



30 185 559



Prodotto Personalizzabile



Coperchio Tau 50



30 194 628

610x410xh27

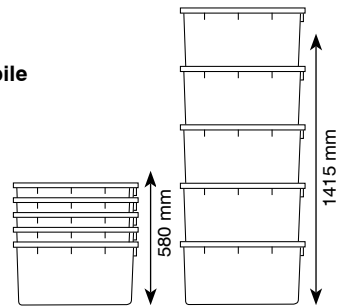

5 Tau 50 sovrapposti = 1415 mm  
5 Tau 50 inseriti = 580 mm

## Tau 70



Codice Prodotto



30 185 550



Prodotto Personalizzabile

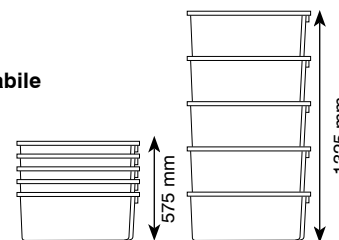

5 Tau 70 sovrapposti = 1325 mm  
5 Tau 70 inseriti = 575 mm



## Tau 30 Grigliato



Codice Prodotto



30 185 555



Prodotto Personalizzabile



### Dati Tecnici

Prodotto	Dimensioni esterne	Dimensioni interne	Peso
Tau 50	600x400xh300	500/535x330/360xh297	2,05 Kg
Tau 70	715x440xh280	600/620x340/365xh275	2,23 Kg
Tau 30 Grigliato	580x395xh175	495x370xh165	1,15 Kg

# CONTENITORI MULTIUSO / MULTIPLE USE CONTAINERS

ORGANIZZAZIONE E STOCCAGGIO / ORGANIZATION AND STORAGE

PORTA RIFIUTI

## CASSONETTI CARRELLATI

Contenitori per la raccolta differenziata di materiali da riciclo e di rifiuti, disponibili in 6 diversi colori per l'identificazione degli scarti.

Special containers for the waste separate collection, available in six different colours for the identification of the waste.

Cassonetti Carrellati per raccolta differenziata		120 Litri	240 Litri	
	●	80 124 450	●	80 124 460
	●	80 124 451	●	80 124 461
	○	80 124 452	○	80 124 462
	●	80 124 453	●	80 124 463
	●	80 124 454	●	80 124 464
	●	80 124 455	●	80 124 465
		80 124 459 Reggisacco per cassonetto		
				
				

### Dati Tecnici

Prodotto	Dimensioni esterne	Capacità	Peso
Cassonetti Carrellati da 120 litri	550x500xh940	120 lt	8,15 Kg
Cassonetti Carrellati da 240 litri	720x580xh1060	240 lt	12,5 Kg

# CONTENITORI MULTIUSO / MULTIPLE USE CONTAINERS

ORGANIZZAZIONE E STOCCAGGIO / ORGANIZATION AND STORAGE

CESTELLI

## JOTA

Cestelli sovrapponibili, in resine atossiche adatte ad usi alimentari. Per il modello Jota 40 è disponibile il carrello metallico.

Stackable baskets made of non-toxic resin, suitable for use with foodstuffs. Jota 40 is also available in a version with a metal trolley.



Jota 40



Carrello per Jota 40



Jota 50

### Jota 40

 30 185 104

 30 185 107

### Carrello per Jota 40

30 130 580 / 505x335xh185

### Jota 50

 80 230 122



Jota 40



## E-SHOP

Scannerizza il QR CODE per accedere direttamente alla pagina ufficiale dello store online.

Scan the QR CODE to directly access the official page of the online store.

## Dati Tecnici

Prodotto	Dimensioni esterne	Dimensioni interne	Peso
Jota 40	540x360 h300	495x325xh280	1,65 Kg (30 185 104)
Jota 50	600x400xh275	565x360xh265	1,595 Kg

# CONTENITORI MULTIUSO / MULTIPLE USE CONTAINERS

ORGANIZZAZIONE E STOCCAGGIO / ORGANIZATION AND STORAGE

CESTELLI

## LAMBDA

Cestello sovrapponibile, sfrutta gli spazi nei piccoli punti vendita. Con ruote pivotanti e distanziatori per combinazioni multipiano.

Stackable crate, ideal in small points of sale. Available with pirouetting wheels and spacer elements to make multilayer combination.

### Lambda



Codice Prodotto

 30 185 123

 30 185 124



### Accessori



Codice Prodotto

 30 240 501 / Distanziatore piccolo h20

 30 240 505 / Distanziatore medio h100

 30 240 510 / Distanziatore grande h175

30 756 523 / Ruota h 90



## E-SHOP

Scannerizza il QR CODE per accedere direttamente alla pagina ufficiale dello store online.

Scan the QR CODE to directly access the official page of the online store.

### Dati Tecnici

Prodotto	Dimensioni esterne	Dimensioni interne	Peso
Lambda	600x400xh150	550x355xh145	1,05 Kg (30 185 123)

# CONTENITORI MULTIUSO / MULTIPLE USE CONTAINERS

ORGANIZZAZIONE E STOCCAGGIO / ORGANIZATION AND STORAGE

USO SPECIFICO

## CONTENITORI ISOTERMICI

Ideali per alimenti, contengono vaschette Gastro-norm 1/1 o sottomultipli. In polipropilene espanso, sono igienici, economici e riciclabili al 100%.

Isothermal containers. Ideal for food, they take Gastronorm 1/1 trays or submultiples. Made by expanded PP, they are hygienic and 100% recyclable.

### Contenitori Isotermici



Codice Prodotto

#### Contenitori isotermici 1

● 53 190 800 / Gastronorm gn1/1 h120 mm

#### Contenitori isotermici 2

● 53 190 801 / Gastronorm gn 1/1 h215 mm

#### Accessori

53 190 810 / inserto gn ice

53 190 811 / piastra eutectica 2200 cm<sup>3</sup>



### E-SHOP

Scannerizza il QR CODE per accedere direttamente alla pagina ufficiale dello store online.

Scan the QR CODE to directly access the official page of the online store.

### Dati Tecnici

Prodotto	Dimensioni esterne	Peso
Contenitore Isotermico 1	600x400xh185	0,67 Kg
Contenitore Isotermico 2	600x400xh280	0,74 Kg

# CONTENITORI MULTIUSO / MULTIPLE USE CONTAINERS

ORGANIZZAZIONE E STOCCAGGIO / ORGANIZATION AND STORAGE

BACINELLE

## GAMMA

Bacinelle in materiale atossico, resistente a grassi e agenti chimici. Utili nelle industrie conserviere e nella lavorazione del pesce.

Basins made by non-toxic material, resistant to fats and chemical agents. Useful in the conserves industry and in fish processing.

### Gamma 1



Codice Prodotto



30 185 001



Prodotto Personalizzabile



### Gamma 2



Codice Prodotto



30 185 002



Prodotto Personalizzabile



### Gamma 3



Codice Prodotto



30 185 003



Prodotto Personalizzabile



### Dati Tecnici

Prodotto	Dimensioni esterne	Dimensioni interne	Peso
Gamma 1	230x180xh42	193x143xh40	0,098 Kg
Gamma 2	310x250xh65	255x195xh60	0,225 Kg
Gamma 3	370x310xh75	315x255xh70	0,375 Kg

# CONTENITORI MULTIUSO / MULTIPLE USE CONTAINERS

ORGANIZZAZIONE E STOCCAGGIO / ORGANIZATION AND STORAGE

BACINELLE



## E-SHOP

Scannerizza il QR CODE per accedere direttamente alla pagina ufficiale dello store online.

Scan the QR CODE to directly access the official page of the online store.

### Gamma 4



Codice Prodotto

30 185 004

Prodotto Personalizzabile



### Gamma 5



Codice Prodotto

30 185 005

Prodotto Personalizzabile



### Gamma 6



Codice Prodotto

30 185 006

Prodotto Personalizzabile



### Dati Tecnici

Prodotto	Dimensioni esterne	Dimensioni interne	Peso
Gamma 4	520x420xh120	430x330xh115	0,76 Kg
Gamma 5	634x534xh140	530x430xh135	1,22 Kg
Gamma 6	848x648xh160	730x530xh155	2,125 Kg

# CONTENITORI MULTIUSO / MULTIPLE USE CONTAINERS

ORGANIZZAZIONE E STOCCAGGIO / ORGANIZATION AND STORAGE

CESTELLI

## PORTABICCHIERI / PORTAPIATTI PORTAPOSATE E ACCESSORI

**Portabicchieri.** Lavaggio e asciugatura.  
**Portapiatti.** Sicura sistemazione dei piatti.  
**Cestello vuoto.** Per oggetti ingombranti.  
**Portaposate.** Adattabile ai cestelli.

**Glasses racks.** Perforated anti-chalk.  
**Dishes rack.** Plates are secured safely.  
**Empty rack.** For bulky objects outside.  
**Cutlery rack.** Fits with the racks.

### Dati Tecnici

	Cestello per bicchieri e calici 3x3	Cestello per bicchieri e calici 4x4	Cestello per bicchieri e calici 5x5	Cestello per bicchieri e calici 6x6	Cestello per bicchieri e calici 7x7
<b>A / cesta base 500x500 h105</b>	53 190 001	53 190 002	53 190 003	53 190 004	53 190 005
	h fino 85mm				
<b>B / cesta base+top 500x500 h150</b>	53 190 011	53 190 021	53 190 031	53 190 041	53 190 051
	h da 86 a 120 mm				
<b>C1 / cesta base+1intermedio+top 500x500 h195</b>	53 190 012	53 190 022	53 190 032	53 190 042	53 190 052
	h da 121 a 160 mm				
<b>C2 / cesta base+2 intermedi+top 500x500 h240</b>	53 190 013	53 190 023	53 190 033	53 190 043	53 190 053
	h da 161 a 200 mm				
<b>C3 / cesta base+3 intermedi+top 500x500 h285</b>	53 190 014	53 190 024	53 190 034	53 190 044	53 190 054
	h da 201 a 240 mm				
<b>C4 / cesta base+4 intermedi+top 500x500 h330</b>	53 190 015	53 190 025	53 190 035	53 190 045	53 190 055
	h da 241 a 280 mm				
<b>Top finale</b>	500x500 h40				



### Top finale per cestelli

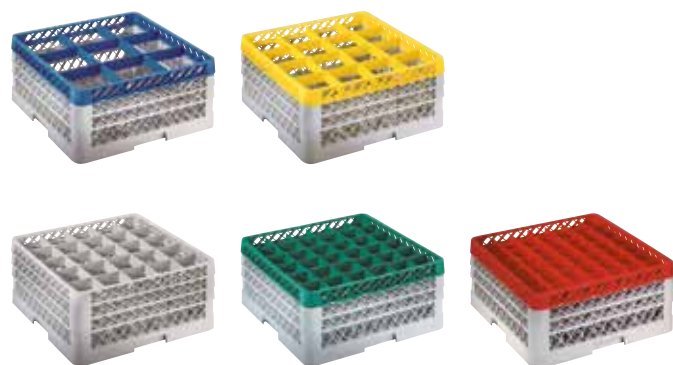

Codice Prodotto

#### Top finale per cestelli 3x3

**53 190 201** / Contiene 9 bicchieri Scompato 154x154

#### Top finale per cestelli 4x4

**53 190 202** / Contiene 16 bicchieri Scompato 112x112

#### Top finale per cestelli 5x5

**53 190 203** / Contiene 25 bicchieri Scompato 91x91

#### Top finale per cestelli 6x6

**53 190 204** / Contiene 36 bicchieri Scompato 74x74

#### Top finale per cestelli 7x7

**53 190 205** / Contiene 49 bicchieri Scompato 63x63

## PORTABICCHIERI / PORTAPIATTI PORTAPOSATE E ACCESSORI

### Cestelli e altri accessori



**Cestello portaposate**



**Cestello vuoto**



**Cestello vuoto per piatti**



**Elemento intermedio**



**Raccogliogocce per carrello**



**Copertina**



**Carrello con manico per cestelli**

Codice Prodotto

**Cestello portaposate**

 **53 190 501** / 430x208xh150

**Cestello vuoto**

 **53 190 700** / 500x500xh105

**Cestello vuoto per piatti**

 **53 190 701** / 500x500xh105

**Elemento intermedio**

 **53 190 300** / 500x500xh40

**Raccogliogocce per carrello**

**30 185 004** / Gamma 4 / 520x420xh120

**Copertina**

**39 412 871** / h1600

**Carrello con manico per cestelli**

**30 130 520** / 530x530xh1130



### E-SHOP

Scannerizza il QR CODE

per accedere direttamente alla pagina ufficiale dello store online.

Scan the QR CODE

to directly access the official page of the online store.

## CONTENITORI DETECTABILI / DETECTABLE CONTAINERS

INDUSTRIA ALIMENTARE / FOOD INDUSTRY

### CONTENITORI DETECTABILI / DETECTABLE CONTAINERS

Gli impianti del settore manifatturiero alimentare sono normalmente dotati di rilevatori che hanno lo scopo di assicurare che all'interno dei prodotti trattati e confezionati non ci siano metalli.

Al fine di rendere un servizio al comparto, Martini Alfredo S.p.A. ha recentemente testato ed introdotto sul mercato una serie di contenitori **detectabili**.

Sono stampati con una particolare resina che, ferme restando le caratteristiche di idoneità al contatto alimentare, è anche **rilevabile al metal detector**.

Gli alimenti che dovessero inglobare frammenti del contenitore, a seguito di rotture/scheggiature accidentali, sono riconosciuti e scartati dalla filiera assicurando quindi che i prodotti sono esenti da corpi estranei sia metallici che plastici.

Per una immediata riconoscibilità anche visiva di eventuali frammenti, la serie **DET** (detectabili) è realizzata nel colore blu.

The food manufacturing industry production plants are normally equipped with detectors which are intended to ensure that within the processed and packaged products there are no metals.

In order to provide a service to the sector, Martini Alfredo SpA have recently tested and introduced on the market a series of **detectable** plastic containers.

They are moulded with a special resin that in addition to being suitable for food is also **detectable by the metal detector**.

Foods that may incorporate fragments of the container, as a result of accidental breakage / chipping, are therefore recognized and rejected from the production line thus ensuring that the processed products are free from both metallic and plastic parts.

For an immediate visual recognizability, the **DET** (detectable) containers are made in blue color.



# CASSETTIERE E SCAFFALATURE

*Più facile lavorare, dal magazzino all'ufficio*

## DRAWERS AND SHELVES

*Working easier, from office to warehouse*

Tutto in ordine e a portata di mano? È facile con i sistemi Martini Alfredo per l'organizzazione e archiviazione di magazzini e uffici.

Do you want everything in its place and within reach? It's child's play with the Martini Alfredo systems for storeroom and office organization.



- 70 **Alfa Mec**
- 71 **Rho Kappa**
- 72 **Beta**
- 72 **Memoria**
- 73 **Dedalo e Eta**
- 73 **Mercurio**
- 73 **Pericle**



# CASSETTIERE E SCAFFALATURE / DRAWERS AND SHELVES

ORGANIZZAZIONE E ARCHIVIAZIONE / ORGANIZATION AND FILING

CASSETTIERE

## ALFA MEC

Cassettera per minuteria metallica, articoli farmaceutici. Si compone di fascione esterno con agnanci laterali e di cassetti in sei misure.

Drawer to hold small metal products or pharmaceutical items. It comprises a broad external casing with side hooks and drawers in six sizes.

### Alfa Mec / Accessori



Codice Prodotto

#### Cassetto Alfa Mec 12

- 30 135 500 Alfa Mec 12/30 120x300xh94
- 30 135 505 Alfa Mec 12/40 120x400xh94
- 30 135 510 Alfa Mec 12/50 120x500xh94

#### Cassetto Alfa Mec 24

- 30 135 520 Alfa Mec 24/30 240x300xh94
- 30 135 525 Alfa Mec 24/40 240x400xh94
- 30 135 530 Alfa Mec 24/50 240x500xh94

#### Fascia Alfa Mec 40

- 30 279 501 / 400x285xh110

#### Cassettera

- 30 136 005 Alfa Mec 12/40 / 285x415xh110 cassetto verde
- 30 136 015 Alfa Mec 24/40 / 285x415xh110 cassetto verde

#### Coperchio

- 32 194 760 Alfa Mec 12/24/40 / 270x395xh3

#### Separatore

- 30 788 501 Alfa Mec 12 / 115x90xh10
- 30 788 510 Alfa Mec 24 / 235x90xh10

#### Etichette

- 30 838 63x / Foglio da 18 etichette

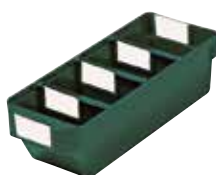

Cassetto Alfa Mec 12



Cassetto Alfa Mec 24



### E-SHOP

Scannerizza il QR CODE per accedere direttamente alla pagina ufficiale dello store online.

Scan the QR CODE to directly access the official page of the online store.

## RHO KAPPA

Cassettera autoportante e autocomponibile, per pareti a magazzino di ogni misura. Cassetti estraibili e sovrapponibili, anche in versione trasparente.

Modular self-supporting drawer unit, the drawers are completely removable and stackable and are available in a transparent version.

### Rho Kappa / Accessori





Codice Prodotto



#### Cassettera cassetto trasparente

-  **30 136 025** Rho K3 / 155x250xh120
-  **30 136 026** Rho K3 / 155x250xh120
-  **30 136 035** Rho K4 / 215x350xh155
-  **30 136 036** Rho K4 / 215x350xh155
-  **30 136 045** Rho K5 / 320x480xh190
-  **30 136 050** Rho K5 / 320x480xh190

#### Cassettera cassetto verde

-  **30 136 030** Rho K3 / 155x250xh120
-  **30 136 040** Rho K4 / 215x350xh155
-  **30 136 055** Rho K5 / 320x480xh190

#### Coperchio

-  **32 194 780** Rho K3 / 140x190xh3
-  **32 194 785** Rho K4 / 200x275xh3
-  **32 194 790** Rho K5 / 300x405xh3

#### Etichette

- 30 838 60x** Rho K3 / foglio da 50 etichette
- 30 838 61x** Rho K4/5 / foglio da 21 etichette

#### Cassetti

-  **30 135 540** Rho K3 / 120x225xh100
-  **30 135 541** Rho K3 / 120x225xh100
-  **30 135 550** Rho K4 / 180x325xh132
-  **30 135 551** Rho K4 / 180x325xh132
-  **30 135 560** Rho K5 / 285x470xh165
-  **30 135 561** Rho K5 / 285x470xh165

#### Fascia

-  **30 279 510** Rho K3 / 150x215xh120
-  **30 279 511** Rho K3 / 150x215xh120
-  **30 279 515** Rho K4 / 215x310xh155
-  **30 279 517** Rho K4 / 215x310xh155
-  **30 279 520** Rho K5 / 320x450xh190
-  **30 279 521** Rho K5 / 320x450xh190



Cassettera cassetto trasparente



Cassettera cassetto verde



### E-SHOP

Scannerizza il QR CODE per accedere direttamente alla pagina ufficiale dello store online.

Scan the QR CODE to directly access the official page of the online store.

# CASSETTIERE E SCAFFALATURE / DRAWERS AND SHELVES

ORGANIZZAZIONE E ARCHIVIAZIONE / ORGANIZATION AND FILING

## CASSETTIERE

### BETA

Il modulo base (fascia e cassetto) della cassettera permette di comporre pareti e divisori per magazzini, laboratori, punti vendita.

The basic module (casing and drawer) of this drawer unit can be used to build walls and partitions for storerooms, workshops and points of sale.

#### Beta / Accessori

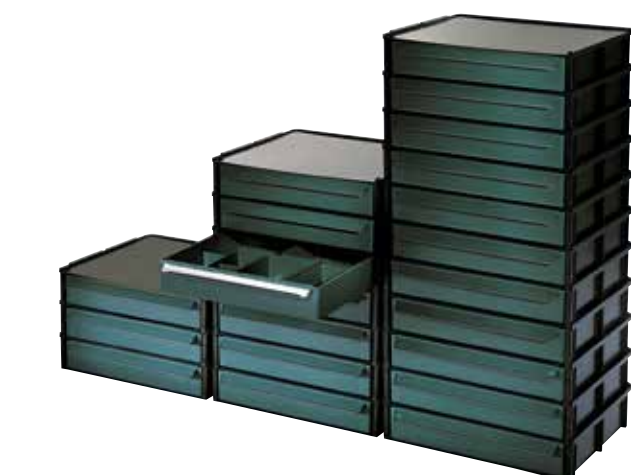





Vaschetta

Codice Prodotto

#### Cassettera

-  **30 136 080** / Beta B\* / 440x375xh90  
Beta B = 1 fascia + 1 cassetto Beta 2  
\* cassetto verde

#### Vaschetta

-  **30 185 560** Beta 4 / 190x150xh62
-  **30 185 570** Beta 6 / 128x150xh62
-  **80 230 580** Beta 10 / 76x150xh60
-  **80 230 590** Beta 20 / 76x150xh60

#### Fascia Beta

-  **30 279 526** / 440x360xh90

#### Cassetto

-  **30 135 570** Beta 2 / 397x355xh70

#### Coperchio

-  **32 194 770** Beta B / 425x350xh3

### MEMORIA

Fascia esterna, cassetto e coperchio antipolvere per il modulo base della cassettera. Perfetta per una rapida archiviazione e gestione dei documenti.



An external casing and a drawer with a dustproof cover for the basic module of this drawer unit. Perfect for filing and rapidly retrieving documents.

#### Memoria





Codice Prodotto

#### Memoria 50

-  **30 136 502**  
fascia + cassetto / 250x395xh75
-  **30 136 512**  
fascia + cassetto / 250x375xh100

#### Memoria 75

-  **30 136 522**  
fascia + cassetto / 375x395xh75
-  **30 136 532**  
fascia + cassetto / 375x375xh100

# CASSETTIERE E SCAFFALATURE / DRAWERS AND SHELVES

ORGANIZZAZIONE E ARCHIVIAZIONE / ORGANIZATION AND FILING

## SCAFFALATURE E PORTACARTE

### DEDALO / ETA

Scaffalature per ufficio semplici da assemblare e adatte ad ogni tipo di materiale. Robuste e indeformabili, sono di facile manutenzione.

Shelf systems for the office that are simple to assemble and suitable for all types of materials. Solid and non-deformable, they are easy to maintain.

#### Dedalo / Eta



Dedalo



Eta



Carrello Dedalo

Codice Prodotto

#### Dedalo

- 30 596 710 pianale / 600x400xh135
- 30 240 552 distanziatore semplice / h80
- 30 240 562 distanziatore doppio / h80
- 30 806 610 spalla / 400x36xh60

30 756 531 ruota

#### Eta

- 30 596 512 pianale / 600x400xh135
- 30 240 522 distanziatore semplice / h80
- 30 240 532 distanziatore doppio / h80
- 30 806 503 spalla / 400x36xh60

#### Carrello Dedalo

- 85 130 514 3 piani / 600x400xh680

### MERCURIO

Portacarte impilabile, con etichette per la rapida identificazione del contenuto.

A stacking document holder with labels for quick content identification.

#### Mercurio



#### Portacarte Mercurio

- 30 260 603 380x265xh70

### PERICLE

Raccoglitori per documenti formato A4 e B4, posizionabili in batteria su scaffali o agganciabili a barra rack.

Binders for A4 and B4 format documents that can be set in stacked on shelves or hooked onto a rack beam.

#### Pericle



#### Raccoglitore Pericle

- 30 260 592 / 360x94xh250
- 30 260 596 / autoestinguente / 360x94xh250

#### Etichette

- 30 838 662 / foglio da 30 etichette
- 30 005 635 / coprietichetta pericle pvc

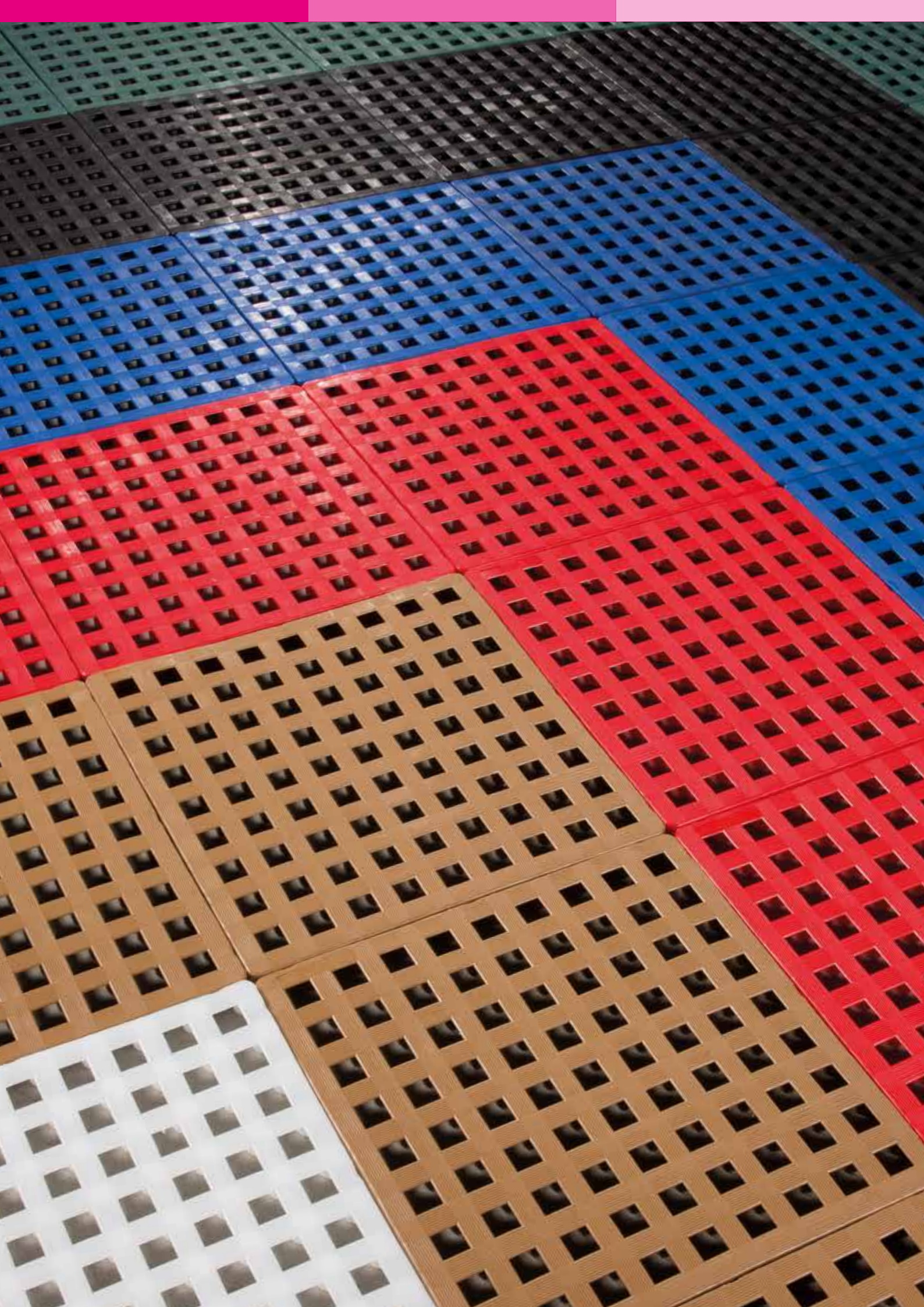

## PAVIMENTAZIONI

*Il sistema più flessibile, dentro e fuori .*

## PAVING SYSTEMS

*The most flexible system, inside and outside.*

Le pavimentazioni componibili garantiscono una base sicura e resistente per interni ed esterni. Sia le soluzioni grigliate che a superficie intera sono isolanti.

These modular floor mat elements ensure that you have a safe and resistant base under feet, both indoors and outdoors. Both the gridded and the full version are insulating.



- 76 **Epsilon**
- 76 **Epsilon Plus**
- 76 **Sigma**



## EPSILON

Grigliato componibile con aggancio fra gli elementi per una facile posa. Resistente ad acidi, solventi e grassi. Disponibili i raccordi col pavimento.





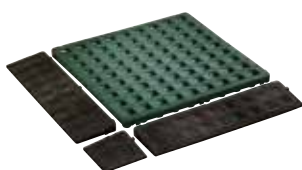

A modular grilled system that hooks the various elements together easy to install. Resistant to acids, solvents and fats. Floor junctions are available.

### Epsilon



#### Codice Prodotto

#### Epsilon

-  **30 260 556** / 500x500xh25
-  **30 260 558** / 500x500xh25
-  **30 260 566** / 500x500xh25
-  **30 260 562** / 500x500xh25
-  **30 260 570** / 500x500xh25
-  **30 260 576** / 500x500xh25
-  **30 260 560** / P.P. 500x500xh25

#### Raccordi

-  **30 260 700**  
laterale, maschio / 500x130x0/25
-  **30 260 701**  
laterale, femmina / 500x130x0/25
-  **30 260 702**  
angolare / 130x130x0/25

I raccordi laterali ed angolari sono validi per tutti i grigliati Epsilon ad eccezione del grigliato nero P.P. cod. 30 260 560 per il quale devono essere utilizzati i raccordi Epsilon Plus.



## EPSILON PLUS

Pavimento componibile a superficie intera, garantisce la perfetta aderenza al pavimento. Anche nelle versioni autoestinguente e conduttiva.

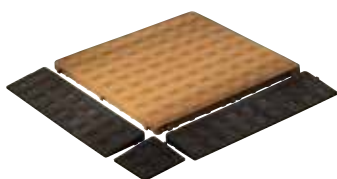

A full surface modular floor system that guarantees perfect adherence to the floor. Also available in self-extinguishing and conductive versions.

### Epsilon Plus





#### Codice Prodotto

#### Epsilon Plus

-  **30 260 530** / 500x500xh25
-  **30 260 535** / 500x500xh25
-  **30 260 538**  
autoestinguente / 500x500xh25

#### Raccordi

-  **30 260 703**  
laterale, maschio / 500x130x0/25
-  **30 260 704**  
laterale, femmina / 500x130x0/25
-  **30 260 705**  
angolare / 130x130x0/25



## SIGMA

Elementi autocomponibili in grado di assorbire le vibrazioni degli impianti ed attutirne i rumori.

Modular elements that can absorb vibrations and deaden the relevant noises.

### Sigma

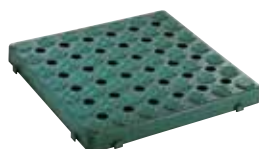

#### Codice Prodotto

#### Sigma 50

-  **30 260 502** / 500x500xh50



# LEGENDA



**Adatto per gli alimenti**  
Suitable for foodstuffs



**Prodotto riciclabile**  
Recyclable

**HDPE**

**Polietilene alta densità**  
High density polyethylene

**PP-E**

**Polipropilene espanso**  
Expanded polypropylene

**PE**

**Polietilene**  
Polyethylene

**PP**

**Polipropilene**  
Polypropylene

**RPP**

**Polipropilene riciclato**  
Recycled polypropylene

**RPE**

**Polietilene riciclato**  
Recycled polyethylene



**Dimensioni unificate europee**  
Standard European dimensions



**Bianco per alimenti**  
Atx white



**Neutro atx**  
Neutral atx



**Bianco**  
White



**Grigio RAL 7001**  
Grey RAL 7001



**Grigio industriale**  
Industrial grey



**Sabbia**  
Sand colour



**Legno**  
Light brown



**Giallo traffico RAL 1023**  
Traffic yellow RAL 1023



**Rosso traffico RAL 3020**  
Traffic red RAL 3020



**Verde per alimenti**  
Atx green



**Verde RAL 6025**  
Green RAL 6025



**Blu oltremare RAL 5002**  
Ultramarine blue RAL 5002



**Nero**  
Black



**Nero atx**  
Black atx



**Trasparente**  
Transparent



**20' DV**

**Container 20 piedi**  
Container 20 feet



**40' DV**

**Container 40 piedi**  
Container 40 feet



**40' HC**

**Container High Cube 40 piedi**  
Container High Cube 40 feet



**45' WB**

**Container Wide Body 45 piedi**  
Container Wide Body 45 feet



**Prodotto Personalizzabile**  
**(su richiesta)**  
**Legato a quantitativi minimi**  
Customizable Product  
(on request)  
Linked to minimum quantities

# INDICI DI RESISTENZA DEL POLIETILENE (PE) E POLIPROPILENE (PP) AGLI AGENTI INDICATI

AGENTE CORROSIVO	CONCENTRAZIONI	PE		20°C	PP 60°C	100°C
		20°C	60°C			
Acetato di Amile		+	+	+	+	o
Acetato di Etile		+	o	+	o	-
Acetato di Piombo	<GL	+	+	+	+	+
Acetone		+	+	+	+	+
Acidi della Frutta		+	+	+	+	+
Acidi Grassi	TR	+	o	+	+	
Acido Acetico	<60%	+	+	+	+	+
Acido Acetico Clorurato	<20%	+	+	+	+	
Acido Adipico		+	+	+	+	+
Acido Benzoico		+	+	+	+	+
Acido Borico	TR	+	+	+	+	+
Acido Butirrico		+	+	+	+	o
Acido Carbonico		+	+	+	+	+
Acido Citrico		+	+	+	+	+
Acido Cloridrico		+	+	+	+	o
Acido Fluorborico		+	+	+	+	
Acido Fluoridrico	<40%	+	o	+	-	
Acido Fluorsilicico		+	+	+	+	+
Acido Formico	<85%	+	+	+	o	
Acido Fosforico	85%	+	+	+	+	+
Acido Glicolico	<GL	+	+	+	o	
Acido Lattico		+	+	+	+	+
Acido Malico		+	+	+	+	+
Acido Nitrico	65%	o		o		
Acido Palmitico		+	+	+	+	o
Acido per Accumulatori	H	+	+	+	+	
Acido Perclorico	10%	+	+	+	+	
Acido Salicinic		+	+	+	+	+
Acido Solfocromico	150 g/l + 50 g/l	-		-		
Acido Solforico	96%	+	o	+	o	
Acido Stearico		+	o	+	o	o
Acido Succinico		+	+	+	+	+
Acido Tartarico		+	+	+	+	+
Acqua Distillata		+	+	+	+	+
Adesivo		+	+	+	+	+
Alcole Etilico		+	+	+	+	
Alcool Metilico	tutte	+	+	+	+	
Ammina di Etanolo	pura	+	+	+	+	o
Ammina di Metile	32%	+	o	+	o	
Ammoniaca in Soluzione Acquosa	<GL	+	+	+	+	
Anidride Carbonica in Forma Gassosa	<GL	+	+	+	+	
Anilina	s.a.s.	+	+	+	+	+
Arsenico	<30%	+	+	+	+	
Bagno di Fissaggio Fotografico	H	+	+	+	+	
Benzina	H	+	o	o	-	
Benzolo di Etile		o	o	o	o	
Birra		+	+	+	+	+
Borace (Tetraborato di Sodio)	<GL	+	+	+	+	+
Borato di Potassio	<GL	+	+	+	+	
Bromato di Potassio	<GL	+	+	+	+	+
Bromuro di Potassio	<GL	+	+	+	+	+
Carbonato di Potassio	<GL	+	+	+	+	+
Carbonato di Sodio		+	+	+	+	+
Cicloesanone	puro	+	+	+	+	o
Clorato di Sodio	<GL	+	+	+	+	+
Cloruro di Alluminio	<GL	+	+	+	+	+
Cloruro di Ammonio	<GL	+	+	+	+	+
Cloruro di Calcio	<GL	+	+	+	+	+
Cloruro di Ferro (II)	<GL	+	+	+	+	
Cloruro di Ferro (III)	<GL	+	+	+	+	+
Cloruro di Magnesio	<GL	+	+	+	+	
Cloruro di Metile		o	o	o	o	o

AGENTE CORROSIVO	CONCENTRAZIONI	PE		20°C	PP 60°C	100°C
		20°C	60°C			
Cloruro di Nichel (II)		+	+	+	+	+
Cloruro di Potassio	<GL	+	+	+	+	+
Cloruro di Rame (II)	<GL	+	+	+	o	
Cloruro di Sodio	<GL	+	+	+	+	+
Cloruro di Zinco		+	+	+	+	+
Combustibile EL	100%	+	o	+	o	
Combustibile per Diesel		+	o	+	o	
Cresolo	s.a.s.	+	+	+	+	+
Diammina di Etile		+	+	+	+	+
Eptano		+	o	+	o	-
Esano		+	o	+	o	o
Etano		+	+	+	+	+
Formaldeide	<15%	+	+	+	+	
Glicerina	<100%	+	+	+	+	
Glicole (Etilenglicole)	TR	+	+	+	+	+
Idrato di Calcio		+	+	+	+	+
Idrato di Sodio	45%	+	+	+	+	+
Ipoclorito di Sodio	attiva 12%	o	-	o	o	-
Ipocloruro di Sodio	attiva 12%	o	-	o	o	-
Isoottano		+	o	+	o	o
Latte		+	+	+	+	+
Limonata		+	+	+	+	+
Lubrificante per Macchine		+	+	+	+	+
Margarina		+	+	+	+	+
Melassa		+	+	+	+	+
Metano		+	+	+	+	+
Nitrato di Ammonio	<GL	+	+	+	+	+
Nitrato di Calcio	<GL	+	+	+	+	+
Nitrato di Potassio	<GL	+	+	+	+	+
Nonilalcole		+	+	+	+	
Olio di Cocco		+	+	+	+	+
Olio di Lino		+	+	+	+	+
Olio di Silicone		+	+	+	+	+
Olio Minerale		+	+	+	+	o
Ossido di Etile		+	+	+	+	
Paraffina		+	+	+	+	+
Persolfato di Potassio	<GL	+	+	+	+	
Potassa Caustica	<50%	+	+	+	+	+
Potassio Permanganato	<10%	+	+	+	o	
Raggi Ultravioletti		+	+	+	+	+
Rivelatore di Sviluppo Fotografico	H	+	+	+	+	
Sale di Sodio		+	+	+	+	
Soda Caustica	15%	+	+	+	+	+
Solfato di Alluminio	<GL	+	+	+	+	+
Solfato di Ammonio	<GL	+	+	+	+	
Solfato di Magnesio	<GL	+	+	+	+	+
Solfato di Nichel	<GL	+	+	+	+	
Solfato di Rame (II)	<GL	+	+	+	+	
Solfuro di Ammonio	<GL	+	+	+	+	
Solfuro di Idrossilammina	<12%	+	+	+	+	
Soluzione Candeggiante Attiva	attiva 12%	o	-	o	o	-
Soluzione di Sapone		+	+	+	+	+
Stirolo		o		o		
Succhi di Frutta		+	+	+	+	+
Tetracloroetilene		+	o	+	o	-
Tricloroetano		o	-	o	-	
Tuolene		o		o		
Urea	<GL	+	+	+	+	
Vino		+	+	+	+	+
Xilene		o	-	o	-	
Zucchero		+	+	+	+	+

I dati riportati nella presente tabella chimica hanno valore semplicemente orientativo. Nessuna garanzia può essere data per le informazioni contenute.

#### LEGENDA

**H** = in commercio  
**GL** = soluzione satura

**TR** = tecnicamente puro  
**S** = sospensione o dispersione

**s.a.s.** = soluzione acquosa satura  
**+** = resistente

**o** = abbastanza resistente  
**-** = non resistente

# POLYETHYLENE (PE) AND POLYPROPYLENE (PP) RESISTANCE INDEXES TO THE MENTIONED AGENTS

CORROSIVE AGENT	CHEMICAL CONCENTRATION	PE		20°C	PP 60°C	100°C
		20°C	60°C			
Acetic Acid	<60%	+	+	+	+	+
Acetic Chlorinated Acid	<20%	+	+	+	+	
Acetone		+	+	+	+	+
Adhesive		+	+	+	+	+
Adipic Acid		+	+	+	+	+
Aluminium Chloride	<GL	+	+	+	+	+
Aluminium Sulphate	<GL	+	+	+	+	+
Ammonia Water	<GL	+	+	+	+	
Ammonium Chloride	<GL	+	+	+	+	+
Ammonium Nitrate	<GL	+	+	+	+	+
Ammonium Sulphate	<GL	+	+	+	+	
Ammonium Sulphate	<GL	+	+	+	+	
Amyl Acetate		+	+	+	+	o
Aniline	s.w.s.	+	+	+	+	+
Arsenic	<30%	+	+	+	+	
Battery Acid	H	+	+	+	+	
Beer		+	+	+	+	+
Benzoic Acid		+	+	+	+	+
Bleaching Active Solution	active 12%	o	-	o	o	-
Borax	<GL	+	+	+	+	+
Boric Acid	TR	+	+	+	+	+
Butyric Acid		+	+	+	+	o
Calcium Chloride	<GL	+	+	+	+	+
Calcium Hydrate	+	+	+	+	+	
Calcium Nitrate	<GL	+	+	+	+	+
Carbon Dioxide	<GL	+	+	+	+	
Carbonic Acid		+	+	+	+	+
Caustic Soda	15%	+	+	+	+	+
Citric Acid		+	+	+	+	+
Coconut Oil		+	+	+	+	+
Copper Chloride (II)	<GL	+	+	+	o	
Copper Sulphate (II)	<GL	+	+	+	+	
Cresol	s.w.s.	+	+	+	+	+
Cyclohexanone	pure	+	+	+	+	o
Diesel		+	o	+	o	
Distilled Water		+	+	+	+	+
Ethane		+	+	+	+	+
Ethanol Amine	pure	+	+	+	+	o
Ethyl Acetate		+	o	+	o	-
Ethyl Alcohol		+	+	+	+	
Ethyl Benzol		o	o	o	o	
Ethyl Diamine		+	+	+	+	+
Ethyl Oxide		+	+	+	+	
Ethylene Glycol	TR	+	+	+	+	+
Fatty Acids	TR	+	o	+	+	
Fixing Bath	H	+	+	+	+	
Fluorboric Acid		+	+	+	+	
Fluorsalicylic Acid		+	+	+	+	+
Formaldehyde	<15%	+	+	+	+	
Formic Acid	<85%	+	+	+	o	
Fruit Acids		+	+	+	+	+
Frutis Juice		+	+	+	+	+
Glycerol	<100%	+	+	+	+	
Glycolic Acid	<GL	+	+	+	o	
Heptane		+	o	+	o	-
Hexane		+	o	+	o	o
Hydrochloric Acid		+	+	+	+	o
Hydrofluoric Acid	<40%	+	o	+	-	
Hydroxilamine Sulphate	<12%	+	+	+	+	
Iron Chloride (II)	<GL	+	+	+	+	
Iron Chloride (III)	<GL	+	+	+	+	+
Isottano		+	o	+	o	o

CORROSIVE AGENT	CHEMICAL CONCENTRATION	PE		20°C	PP 60°C	100°C
		20°C	60°C			
Lactic Acid		+	+	+	+	+
Lemonade		+	+	+	+	+
Lead Acetate	<GL	+	+	+	+	
Linseed Oil		+	+	+	+	+
Lubricating Oil		+	+	+	+	+
Magnesium Chloride	<GL	+	+	+	+	
Magnesium Sulphate	<GL	+	+	+	+	+
Malic Acid		+	+	+	+	+
Methanol		+	+	+	+	+
Methyl Alcohol	all	+	+	+	+	
Metil Amina	32%	+	o	+	o	
Metyl Chloride		o	o	o	o	o
Milk		+	+	+	+	+
Mineral Oil		+	+	+	+	o
Molasses		+	+	+	+	+
Nichel Chloride (II)		+	+	+	+	+
Nichel Sulphate	<GL	+	+	+	+	
Nitric Acid	65%	o		o		
Nonyl Alcohol		+	+	+	+	
Oleo Margarine		+	+	+	+	+
Palmitic Acid		+	+	+	+	o
Paraffin		+	+	+	+	+
Perchloric Acid	10%	+	+	+	+	
Petrol	H	+	o	o	-	
Photos Developper	H	+	+	+	+	
Phosphoric Acid	85%	+	+	+	+	+
Potassium Borate	<GL	+	+	+	+	
Potassium Bromate	<GL	+	+	+	+	+
Potassium Bromide	<GL	+	+	+	+	+
Potassium Carbonate	<GL	+	+	+	+	+
Potassium Chloride	<GL	+	+	+	+	+
Potassium Hydroxide	<50%	+	+	+	+	+
Potassium Manganate	<10%	+	+	+	o	
Potassium Nitrate	<GL	+	+	+	+	+
Potassium Sulphate	<GL	+	+	+	+	
Salicylic Acid		+	+	+	+	+
Silicon Oil		+	+	+	+	+
Sodium Salt		+	+	+	+	
Sodium Carbonate		+	+	+	+	+
Sodium Chlorate	<GL	+	+	+	+	+
Sodium Chloride	<GL	+	+	+	+	+
Sodium Hydrate	45%	+	+	+	+	+
Sodium Hypochloride	active 12%	o	-	o	o	-
Sodium Hypochloride	active 12%	o	-	o	o	-
Stearic Acid		+	o	+	o	o
Styrole		o		o		
Succinic Acid		+	+	+	+	+
Suds		+	+	+	+	+
Sugar		+	+	+	+	+
Sulphchromic Acid	150 g/l + 50 g/l	-		-		
Sulphoric Acid	96%	+	o	+	o	
Tartaric Acid		+	+	+	+	+
Tetrachloride Ethylene		+	o	+	o	-
Trichloroethano		o	-	o	-	
Tuolene		o		o		
Unlead Fuel	100%	+	o	+	o	
Urea	<GL	+	+	+	+	
UV		+	+	+	+	+
Wine		+	+	+	+	+
Xilene		o	-	o	-	
Zinc Chloride		+	+	+	+	+

Data contained in this chemical resistance chart are guidelines. No guarantee can be provided for the reported information.

#### KEY

**H** = commonly in commerce  
**GL** = saturated solution

**TR** = technically pure  
**S** = suspension or dispersion

**s.w.s** = saturated water solution  
**+** = c.a. (corrosion agent) proof

**o** = c.a. quite proof  
**-** = c.a. unproof

# IL SERVIZIO VENDITE / THE SALES NETWORK

LA LOGISTICA DELL'EFFICIENZA E TEMPESTIVITÀ

THE LOGISTIC OF EFFICIENCY AND TIMELINESS

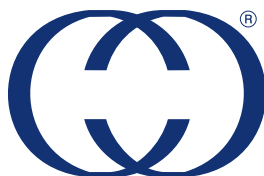

**MARTINI ALFREDO**

## IL SERVIZIO VENDITE.

### LA LOGISTICA DELL'EFFICIENZA E TEMPESTIVITÀ.

Cuore logistico la sede centrale. Una rete di 13 magazzini su tutto il territorio nazionale. Numerosi agenti locali per il mercato estero. Il risultato: una distribuzione capillare, efficiente e puntuale.

## THE SALES NETWORK.

### THE LOGISTIC OF EFFICIENCY AND TIMELINESS.

The logistic heart. The headquarters manage a network of 13 branches spread on the domestic territory, several agents and distributors for the export market. The result is an efficient, punctual and widespread distribution.

#### Lombardia

25030 Adro (BS)  
Zona Industriale  
Via Lucerna, 8/a  
(uscita A4 Palazzolo S/O - Km 1)  
Tel. 030 7450881  
Fax 030 7453584

#### Piemonte

10137 Torino  
Tel. 335 7023640  
Fax 011 5611886

#### Veneto

35020 Maserà  
di Padova (PD)  
Via Bolzani 104/b  
(laterale ss 16 adriatica)  
Tel. 049 711955  
Fax 049 8625287

#### Liguria

16146 Genova  
Via Eleonora Duse, 86/94  
(accesso da via Pio X)  
Tel. 010 3620073  
Fax 010 3694617

#### Emilia Romagna

43122 Parma  
S. Lazzaro  
Via Tagliani, 7  
Tel. 0521 242512  
Fax 0521 468126

#### 40068 San Lazzaro di Savena (BO)

Via della Tecnica, 45  
Tel. 051 6814724  
Fax 051 6257627

#### Toscana

50041 Calenzano (FI)  
Via dei Gelsi, 25  
Tel. e Fax 055 8825164

#### Marche e Abruzzo

60025 Loreto (AN)  
Via Brodolini, 7 - Zona Industriale  
Tel. e Fax 071 7501041

#### Lazio

00166 Roma  
Via G. Neper, 14  
Tel. 06 66181100  
Fax 06 66181149

#### Campania

80038 Pomigliano D'Arco (NA)  
Via Abate Felice Toscano, 176  
Tel. 335 6665527 - Fax 081 5210683

#### Puglia e Basilicata

70026 Modugno (BA)  
Via delle Magnolie, 17 - Zona Industriale  
Tel. 080 9753024  
Fax 080 9753024

#### Sicilia

90100 Palermo  
Tel. 335 1434916  
Fax 091 6257847

#### Sardegna

09122 Cagliari  
V.le Monastir, 138  
Tel. 347 6015355  
Fax 070 3110849

1945  
2015  
70



## LA SQUADRA MARTINI ALFREDO / THE MARTINI ALFREDO TEAM

UNA SQUADRA DI PROFESSIONISTI AL VOSTRO SERVIZIO

A PROFESSIONAL TEAM AT YOUR SERVICE

---



La Martini Alfredo S.p.A. si riserva il diritto di modificare senza alcun preavviso le caratteristiche dei prodotti presentati in questo catalogo. La linea dei contenitori "Martini Alfredo" per uso alimentare è conforme alle norme vigenti. Tutte le misure riportate sono espresse in millimetri. I dati inerenti la portata si riferiscono ad un carico ugualmente ed uniformemente distribuito. I valori indicati sono tutti nominali, con una tolleranza di  $\pm 3\%$  in funzione del materiale. Ogni garanzia verrà a decadere qualora gli articoli saranno utilizzati in modo improprio. Foro competente: Como (Italia).

*Martini Alfredo S.p.A. reserves the right to alter the characteristics of the products presented in this catalogue without prior notice. The "Martini Alfredo" collection of containers for use with foodstuffs complies with current legislation. All the dimensions quoted here are expressed in millimetres. Load statistics refer to an equally and uniformly distributed load. All the values expressed are nominal, with a tolerance of the  $\pm 3\%$  in function of the material. All guarantees and warranties become null and void if the articles in question are used improperly. Jurisdiction in case of conflict is vested in the courts of Como (Italy).*

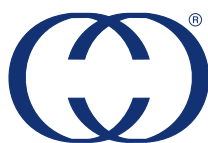

**MARTINI ALFREDO**

Via Centro Industriale Europeo, 43  
22078 Turate (CO)  
Tel. 02 963941  
commerciale@martinialfredo.it  
www.martinialfredo.it

